

**measuring light screen
receiver
BMRL3016A**

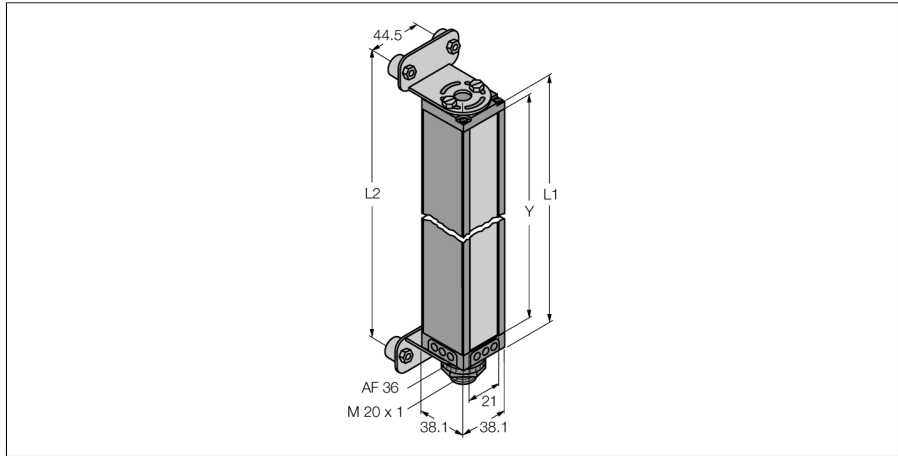

- Minimum target size 19 mm
- Scan field 752 mm
- max. sensing range 17 m
- Operating voltage 11.8...12.2 VDC (from controller)
- Protection class IP65
- adjustment via software

Functional principle

Measuring light screens are ideally suited for precise detection and inspection tasks such as product profiling, sizing, edge and centre guiding, hole and parts detection and the like. Each system consists of an emitter, receiver and a controller module, which is equipped with several switching and analogue outputs, depending on the specific version. The device also enables data transmission via RS232 or R485, either in a binary or ASCII code format. The scan times depend on the height of the measuring array and the adjusted scan mode. Detailed information can be taken from the instruction manual.

Type code	BMRL3016A
Ident no.	3039584
Operating mode	light screen
Optical resolution	19 mm
Range	900...17000 mm
Detection zone height	752 mm
Ambient temperature	-20...+70 °C
Operating voltage	11.4...14VDC
Design	rectangular, Mini Array
Dimensions	38.1 x 38.1 x 810 mm
Housing material	metal, AL
Lens	plastic, acrylic
Connection	male, 7/8"
Protection class	IP65