

**measuring light screen
emitter
EA5E150Q**

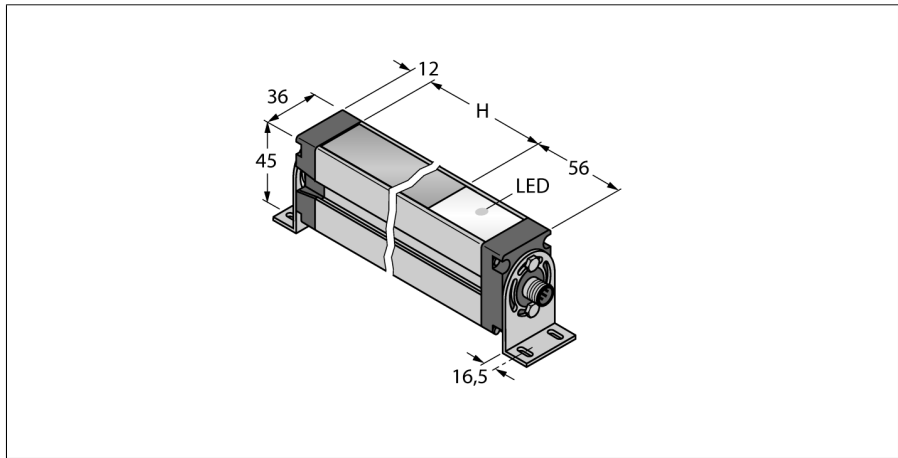

- Male M12 x 1, 8-pin
- Scan field 150 mm
- Protection class IP65
- Resolution 5 mm
- Max. sensing range 4 m
- Operating voltage 12...30 VDC
- Mounting bracket EZA-MBK-11 (for all types) and EZA-MBK-12 (only for ranges ≥ 1050 mm) incl. in delivery

Wiring diagram

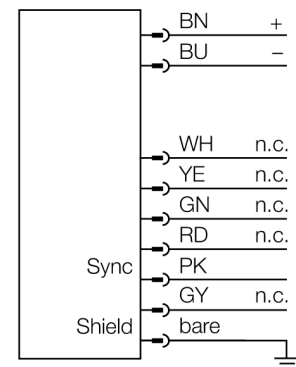

Functional principle

The measuring light screen EZ-Array is ideal for sizing and product profiling, edge and centre guiding, sag and hole detection as well as parts counting. The two-part light screen is easily installed. The electronics is incorporated in the receiver housing and can be configured via 6 DIP switches. For special functions, the screen can be adjusted via PC with the enclosed software. To synchronize emitter and receiver just interconnect the sync-outputs of both.

Type code	EA5E150Q
Ident no.	3075423
Operating mode	light screen
Light type	IR
Optical resolution	5 mm
Range	400...4000 mm
Detection zone height	150 mm
Ambient temperature	-40...+70 °C
Operating voltage	12...30VDC
No-load current I ₀	≤ 400 mA
Readiness delay	≤ 2 s
Design	rectangular, EZ-Array
Dimensions	45.2 x 36 x 227 mm
Housing material	metal, AL, anodized
Lens	plastic, acrylic
Connection	male, M12 x 1
Protection class	IP65
Power-on indication	LED red

measuring light screen
emitter
EA5E150Q

Accessories

Type code	Ident no.	Description	Dimension drawing
EZA-MBK-11	3071470	Mounting bracket, steel, black-finished, for EZ-ARRAY and EZ-SCREEN standard and cascade 14 & 30 mm	
EZA-MBK-12	3071756	Mounting bracket, steel, black-finished, for EZ-ARRAY and EZ-SCREEN standard and cascade 14 & 30 mm	
EZA-MBK-20	3072587	Mounting bracket, steel, black-finished, for EZ-ARRAY and EZ-SCREEN standard 14 & 30 mm	

Wiring accessories

Type code	Ident no.	Description	Dimension drawing
RKC8T-2/TEL	6625130	Connection cable, female M12, straight, 8-pin, cable length: 2 m; sheath material: PVC, sheath color: black, cULus approved, RoHS conform, protection class IP67	
WKC8T-2/TEL	6625133	Connection cable, female M12, angled, 8-pin, cable length: 2 m; sheath material: PVC, sheath color: black, cULus approved, RoHS conform, protection class IP67	