

**Photoelectric sensor
luminescence sensor
QL55M6XD15BQ**

TURCK

Industrial
Automation

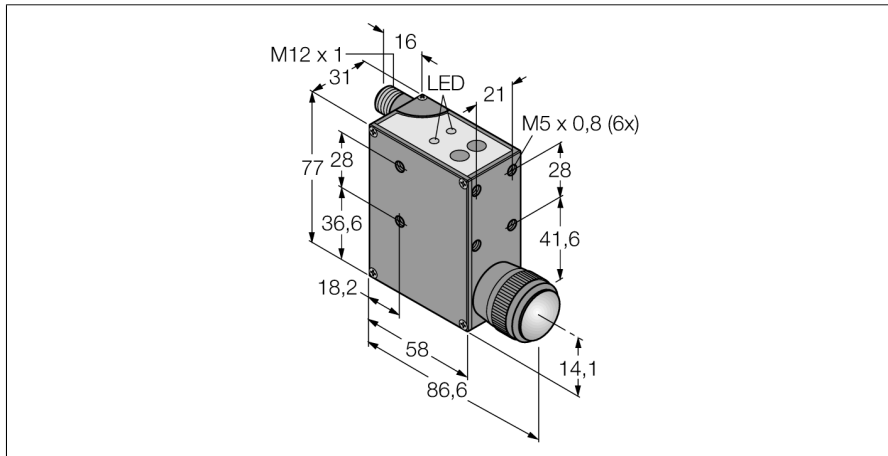

- Protection class IP67
- M12 x 1 connector rotatable by 90 °
- Operating voltage 10...30 VDC
- PNP or NPN switching output
- 0...7 V analog output
- Non-volatile EEPROM memory

Wiring diagram

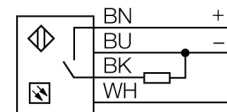

Type code	QL55M6XD15BQ
Ident no.	3070938
Operating mode	luminescence sensor
Light type	UV
Light spot diameter	2 mm
Range	9...18 mm
Ambient temperature	-10...+55 °C
Operating voltage	10...30VDC
DC rated operational current	≤ 100 mA
No-load current I ₀	≤ 200 mA
Output function	NO contact, PNP/analog output
Switching frequency	2 kHz
Design	rectangular, QL55
Dimensions	77 x 31 x 58 mm
Housing material	metal, ZNAl4
Lens	glass
Connection	male, M12 x 1
Protection class	IP67
Switching state	LED red

Functional principle

The QL55 is a user-friendly compact luminescence sensor, which emits invisible ultraviolet light via its UV emitting LED and detects the resulting visible luminescent light of the medium. Detection is enabled through conversion of the light wave length with the reflection on media which contain luminescent substrates. Due to its compact size it can be easily mounted almost everywhere. The configuration options comprise a programming mode for adjustment of the sensitivity as well as a fine tuning option for a large range of luminescence intensities and background conditions. Alongside the choice between an npn or pnp switching output, there is also an analogue voltage output available.

