

czujnik fotoelektryczny
luminescence sensor
QL55M6XD15BQ

TURCK

Industrial
Automation

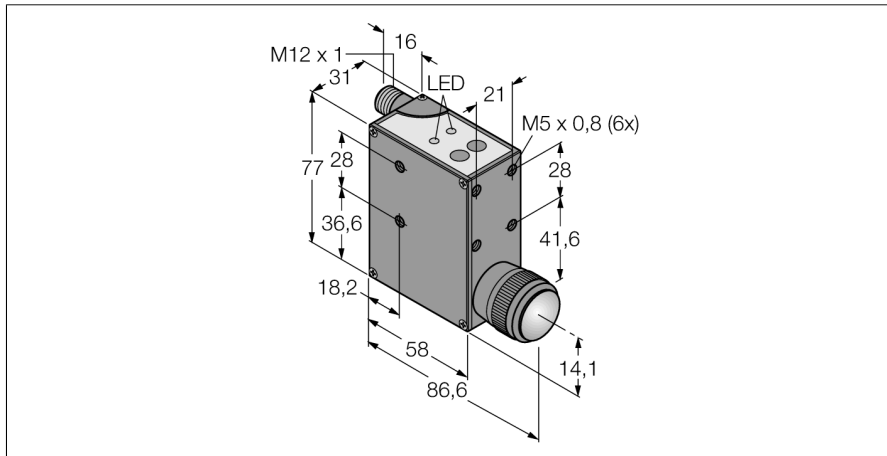

- Protection class IP67
- M12 x 1 connector rotatable by 90 °
- Operating voltage 10...30 VDC
- PNP or NPN switching output
- 0...7 V analog output
- Non-volatile EEPROM memory

Schemat podłączenia

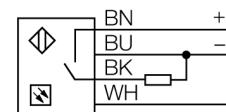

Typ	QL55M6XD15BQ
Nr kat.	3070938
Tryb pracy	czujnik luminescencyjny
Rodzaj światła	UV
Light spot diameter	2 mm
Max zakres wykrywania	9...18 mm
Temperatura pracy	-10...+55 °C
Napięcie zasilania	10...30VDC
Nominalny prąd zasilania DC	≤ 100 mA
Prąd bez obciążenia I ₀	≤ 200 mA
Funkcja wyjścia	styk NO, PNP/wyjście analogowe
Częstotliwość przełączania	2 kHz
Wykonanie	prostokątnościenna, QL55
Wymiary	77 x 31 x 58 mm
Materiał obudowy	metal, ZNAl4
Soczewka	szkło
Podłączenie	złącze, M12 x 1
Stopień ochrony	IP67
Wskaźnik stanu przełączenia	LED czerwony

Zasada działania

The QL55 is a user-friendly compact luminescence sensor, which emits invisible ultraviolet light via its UV emitting LED and detects the resulting visible luminescent light of the medium. Detection is enabled through conversion of the light wave length with the reflection on media which contain luminescent substrates. Due to its compact size it can be easily mounted almost everywhere. The configuration options comprise a programming mode for adjustment of the sensitivity as well as a fine tuning option for a large range of luminescence intensities and background conditions. Alongside the choice between an npn or pnp switching output, there is also an analogue voltage output available.

