

**Photoelectric sensor  
opposed mode sensor (emitter)  
Q406EQ**

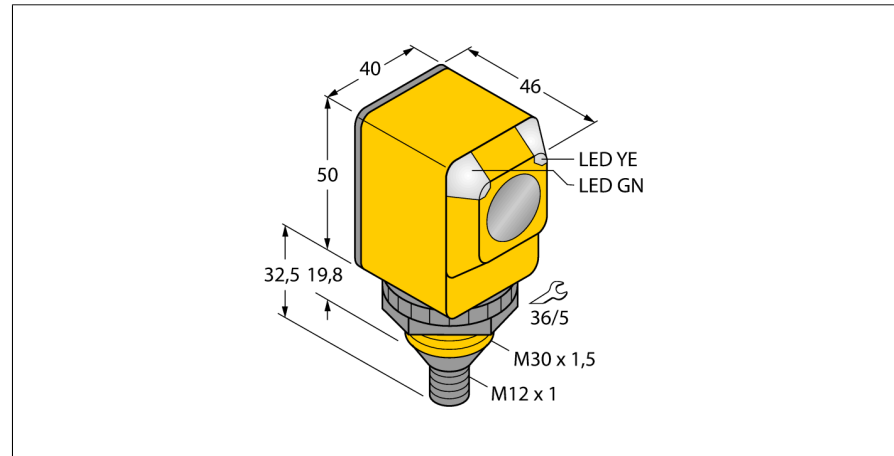

- Male M12 x 1, 5-pin
- Protection classes IP67/IP69K
- Ambient temperature: -40...+70 ° C
- Operating voltage: 10...30 VDC

**Wiring diagram**



**Functional principle**

Opposed mode sensors consist of an emitter and receiver. They are installed opposite to each other so that the light from the emitter is aimed directly at the receiver. When an object interrupts or weakens the light beam, the sensor switches. Opposed mode sensors are the most reliable photoelectric sensors for detection of opaque targets. The excellent light/dark contrast and the high excess gain allow operation over larger distances and under difficult conditions.

**Excess gain curve**

Excess gain in relation to the distance

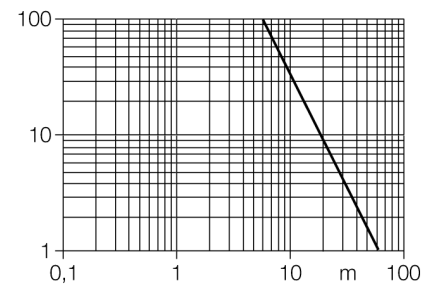

<b>Type code</b>	Q406EQ
Ident no.	3033398
<b>Operating mode</b>	opposed mode sensor (emitter)
Light type	IR
Wavelength	950 nm
Range	0...60000 mm
Ambient temperature	-40...+70 °C
<b>Operating voltage</b>	10...30VDC
Residual ripple	< 10 % U <sub>s</sub>
No-load current I <sub>0</sub>	≤ 20 mA
<b>Design</b>	rectangular, Q40
Dimensions	46 x 40.1 x 82.5 mm
Housing material	plastic, PBT
Lens	plastic, Lexan
Connection	male, M12 x 1
Cable cross section	2 mm <sup>2</sup>
Protection class	IP67 / IP69K
<b>Power-on indication</b>	LED green

**Photoelectric sensor  
opposed mode sensor (emitter)  
Q406EQ**

**TURCK**

Industrial  
Automation

**Accessories**

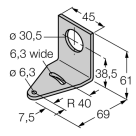
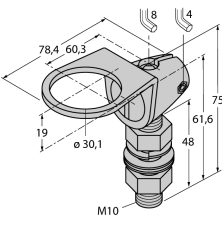
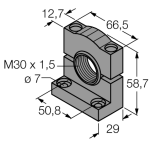
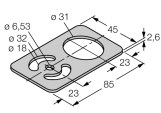
Type code	Ident no.	Description	Dimension drawing
SMB30A	3032723	Mounting bracket, stainless steel, for sensors with 30 mm thread	
SMB30FAM10	3011185	Mounting bracket, stainless steel, for M10 x 1.5 thread, thread length 30 mm	
SMB30SC	3052521	Mounting bracket, PBT black; for 30 mm thread; with 4 screws M5 x 0.8	
SMBAMS30P	3073135	Mounting bracket, stainless steel, for sensors with 30 mm thread	

**Wiring accessories**

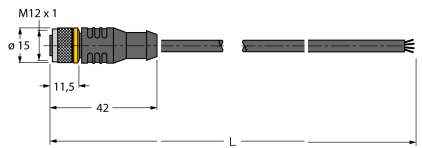
Type code	Ident no.	Description	Dimension drawing
RKC4.4T-2/TEL	6625013	Connection cable, female M12, straight, 4-pin, cable length: 2 m, sheath material: PVC, black; cULus approval; other cable lengths and qualities available, see <a href="http://www.turck.com">www.turck.com</a>	

**Photoelectric sensor  
opposed mode sensor (emitter)  
Q406EQ**

**Wiring accessories**

Type code	Ident no.	Description	Dimension drawing
WKC4.4T-2/TEL	6625025	Connection cable, female M12, angled, 4-pin, cable length: 2 m, sheath material: PVC, black; cULus approval; other cable lengths and qualities available, see <a href="http://www.turck.com">www.turck.com</a>	