

**Photoelectric sensor
opposed mode sensor (emitter)
T186EQ**

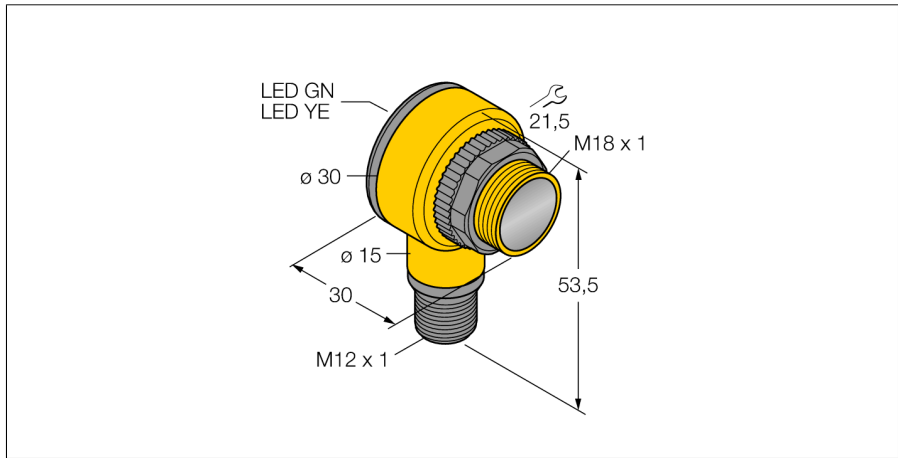

- Male M12 x 1, 5-pin
- Protection classes IP67/IP69K
- Ambient temperature: -40...+70 ° C
- Operating voltage: 10...30 VDC

Wiring diagram

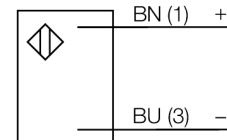

Functional principle

Opposed mode sensors consist of an emitter and receiver. They are installed opposite to each other so that the light from the emitter is aimed directly at the receiver. When an object interrupts or weakens the light beam, the sensor switches. Opposed mode sensors are the most reliable photoelectric sensors for detection of opaque targets. The excellent light/dark contrast and the high excess gain allow operation over larger distances and under difficult conditions.

Excess gain curve

Excess gain in relation to the distance

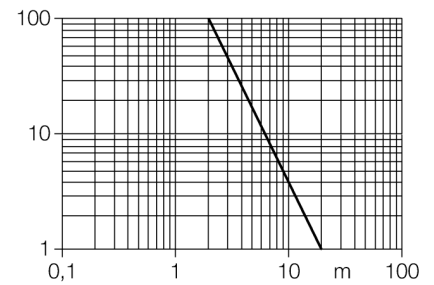

Type code	T186EQ
Ident no.	3033420
Operating mode	opposed mode sensor (emitter)
Light type	IR
Wavelength	950 nm
Range	0...20000 mm
Ambient temperature	-40...+70 °C
Operating voltage	10...30VDC
Residual ripple	< 10 % U _s
No-load current I ₀	≤ 20 mA
Design	cylindrical/threaded, T18
Dimensions	30 x 30 x 54 mm
Housing material	plastic, PBT
Lens	plastic, Lexan
Connection	male, M12 x 1
Cable cross section	2 mm ²
Protection class	IP67 / IP69K
Power-on indication	LED green

**Photoelectric sensor
opposed mode sensor (emitter)
T186EQ**

TURCK

Industrial
Automation

Accessories

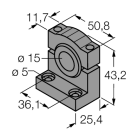
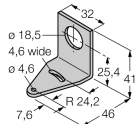
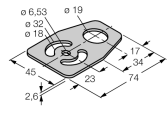
Type code	Ident no.	Description	Dimension drawing
SMB1815SF	3053279	Mounting bracket, PBT black, for PICO-GUARD points	
SMB18A	3033200	Mounting bracket, stainless steel, for sensors with 18 mm thread	
SMB18FM	3079421	mounting bracket, black, M22 x1.5 mm, male thread, female thread M18 x 1, for sensors with 18 mm thread	
SMBAMS18P	3073134	Mounting bracket, stainless steel, for sensors with 18 mm thread	

Wiring accessories

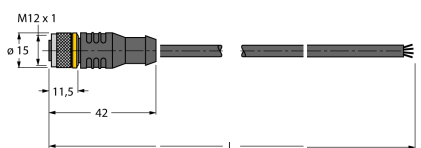
Type code	Ident no.	Description	Dimension drawing
RKC4.4T-2/TEL	6625013	Connection cable, female M12, straight, 4-pin, cable length: 2 m, sheath material: PVC, black; cULus approval; other cable lengths and qualities available, see www.turck.com	
WKC4.4T-2/TEL	6625025	Connection cable, female M12, angled, 4-pin, cable length: 2 m, sheath material: PVC, black; cULus approval; other cable lengths and qualities available, see www.turck.com	