

**Photoelectric sensor
opposed mode sensor (emitter)
Q456EQ5**

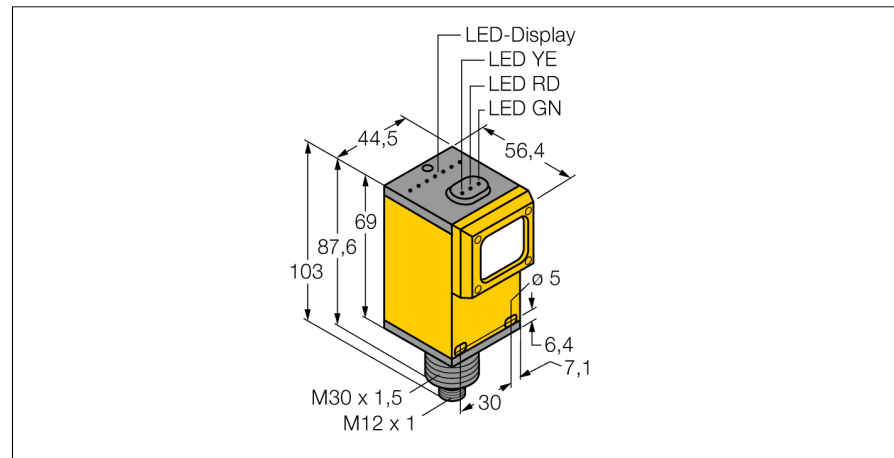

- Male M12 x 1
- Protection class IP67
- Male connector M12 x 1
- Operating voltage: 10...30 VDC

Wiring diagram

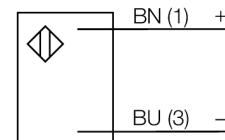

Type code	Q456EQ5
Ident no.	3038659
Operating mode	opposed mode sensor (emitter)
Light type	IR
Wavelength	880 nm
Range	0...60000 mm
Operating voltage	10...30VDC
No-load current I ₀	≤ 50 mA
Readiness delay	≤ 100 ms
Design	rectangular, Q45
Dimensions	56.4 x 44.5 x 102.6 mm
Housing material	plastic, PBT
Lens	plastic, acrylic
Connection	male, M12 x 1
Protection class	IP67
MTTF	67 years acc. to SN 29500 (Ed. 99) 40 °C
Power-on indication	LED green

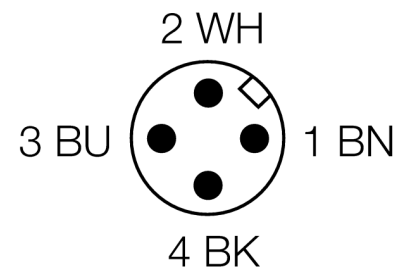

Functional principle

Opposed mode sensors consist of an emitter and receiver. They are installed opposite each other so that the light from the emitter is aimed directly at the receiver. When an object interrupts or weakens the light beam, the sensor switches. Opposed mode sensors are the most reliable photoelectric sensors for detection of opaque targets. An excellent contrast between light and dark conditions and an extremely high excess gain are typical of this sensing mode, thus allowing operation over larger distances and under difficult conditions.

Excess gain curve

Excess gain in relation to the distance

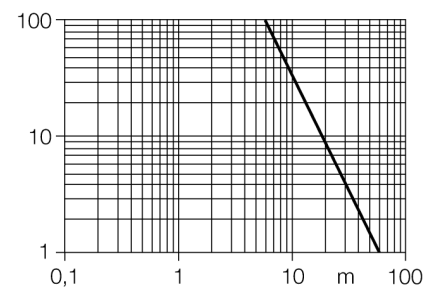

**Photoelectric sensor
opposed mode sensor (emitter)
Q456EQ5**

TURCK

Industrial
Automation

Accessories

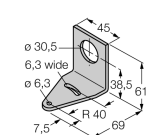
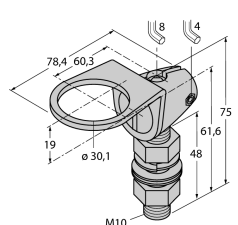
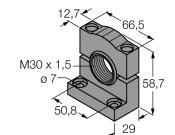
Type code	Ident no.	Description	Dimension drawing
SMB30A	3032723	Mounting bracket, stainless steel, for sensors with 30 mm thread	
SMB30FAM10	3011185	Mounting bracket, stainless steel, for M10 x 1.5 thread, thread length 30 mm	
SMB30SC	3052521	Mounting bracket, PBT black; for 30 mm thread; with 4 screws M5 x 0.8	

Wiring accessories

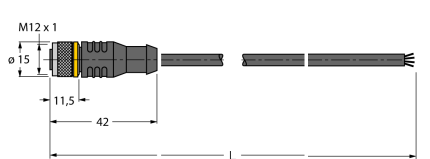
Type code	Ident no.	Description	Dimension drawing
RKC4.4T-2/TEL	6625013	Connection cable, female M12, straight, 4-pin, cable length: 2 m, sheath material: PVC, black; cULus approval; other cable lengths and qualities available, see www.turck.com	
WKC4.4T-2/TEL	6625025	Connection cable, female M12, angled, 4-pin, cable length: 2 m, sheath material: PVC, black; cULus approval; other cable lengths and qualities available, see www.turck.com	