

**Photoelectric sensor
opposed mode sensor (emitter/receiver)
SM31RL**

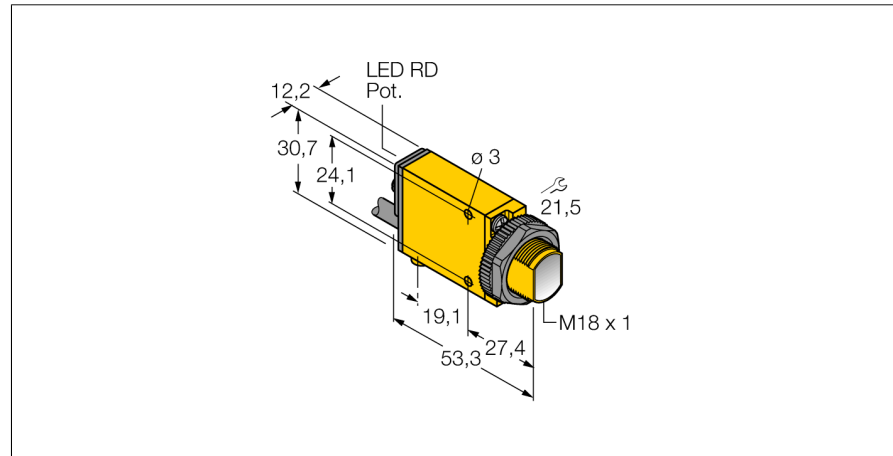

- Cable, PVC, 2 m
- Protection class IP67
- Sensitivity adjustable via potentiometer
- Alignment indicator
- Operating voltage: 10...30 VDC
- Switching output, bipolar
- Light/dark operation

Wiring diagram

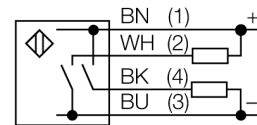

Type code	SM31RL
Ident no.	3025725
Operating mode	opposed mode sensor (receiver)
Range	0...30000 mm
Ambient temperature	-20...+70 °C
Operating voltage	10...30VDC
Residual ripple	< 10 % U _{in}
DC rated operational current	≤ 150 mA
No-load current I ₀	≤ 25 mA
Output function	NO contact, PNP/NPN
Switching frequency	≤ 500 Hz
Readiness delay	≤ 100 ms
Overcurrent release	> 220 mA
Design	rectangular, Mini Beam
Dimensions	53.3 x 12.3 x 30.7 mm
Housing material	plastic, PBT, yellow
Lens	plastic, acrylic
Connection	cable, PVC
Cable length	2 m
Cable cross section	4 x 0.5 mm ²
Protection class	IP67
MTTF	777 years acc. to SN 29500 (Ed. 99) 40 °C
Switching state	LED red
Excess gain indication	LED red flashing

Functional principle

Opposed mode sensors consist of an emitter and receiver. They are installed opposite each other so that the light from the emitter is aimed directly at the receiver. When an object interrupts or weakens the light beam, the sensor switches. Opposed mode sensors are the most reliable photoelectric sensors for detection of opaque targets. An excellent contrast between light and dark conditions and an extremely high excess gain are typical of this sensing mode, thus allowing operation over larger distances and under difficult conditions.

Excess gain curve

Excess gain in relation to the distance

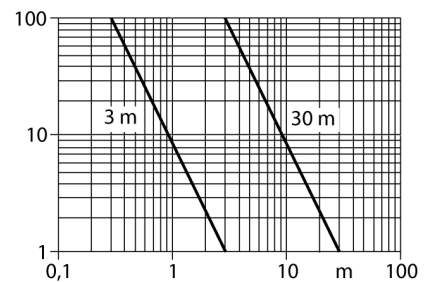

Photoelectric sensor
 opposed mode sensor (emitter/receiver)
 SM31RL

Accessories

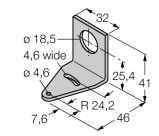
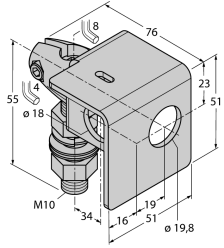
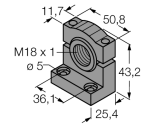
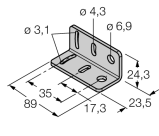
Type code	Ident no.	Description	Dimension drawing
SMB18A	3033200	Mounting bracket, stainless steel, for sensors with 18 mm thread	
SMB18AFAM10	3012558	Mounting bracket, material VA 1.4401, for M10 x 1.5 thread, thread length 18 mm	
SMB18SF	3052519	Mounting bracket, PTB black steel, for sensors with 18 mm thread	
SMB312B	3025519	Mounting bracket, stainless steel, for MINI-BEAM NAMUR	
SMB3018SC	3053952	Mounting bracket, PTB black, for sensors with 18 mm thread	