

**Photoelectric sensor  
opposed mode sensor (receiver)  
S18SN6RQ**

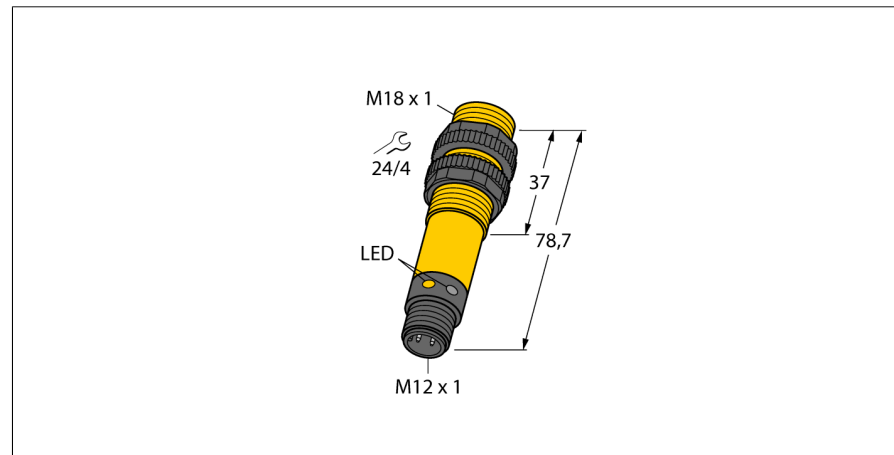

- Male M12 x 1, 5-pin
- Protection classes IP67/IP69K
- Ambient temperature: -40...+70 ° C
- Selectable light/dark operation or light operation with alarm function
- Operating voltage: 10...30 VDC
- NPN switching output, changeover

**Wiring diagram**

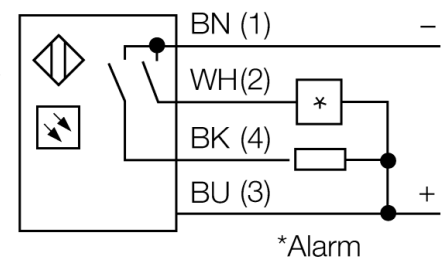
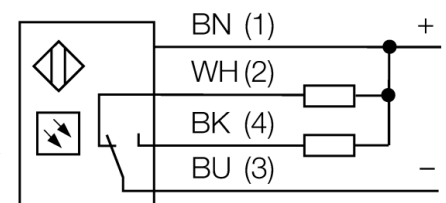

**Functional principle**

Opposed mode sensors are composed of an emitter and a receiver, both separately housed. When installed, the emitter light should directly aim at the receiver. If an object interrupts or weakens the light beam, the sensor switches. Opposed mode sensors are the most reliable photoelectric sensors for detection of opaque targets. Large distance operation is possible due to an excellent light/dark contrast and an extremely high excess gain. Even in case of dirt build-up on the lens or misalignment the sensor type works reliably.

<b>Type code</b>	S18SN6RQ
Ident no.	3029506
<b>Operating mode</b>	opposed mode sensor (receiver)
Range	0...20000 mm
Ambient temperature	-40...+70 °C
<b>Operating voltage</b>	10...30VDC
DC rated operational current	≤ 150 mA
No-load current I <sub>0</sub>	≤ 25 mA
Short-circuit protection	yes/ cyclic
Reverse polarity protection	yes
Output function	connection programmable, NPN
Switching frequency	≤ 160 Hz
Readiness delay	≤ 100 ms
Overcurrent release	> 220 mA
<b>Design</b>	cylindrical/threaded, S18
Dimensions	78.7 mm
Housing diameter	18 mm
Housing material	plastic, PBT
Lens	Lexan, Lexan
Connection	male, M12 x 1
Protection class	IP67 / IP69K
<b>Power-on indication</b>	LED green
Switching state	LED yellow
Error indication	LED green flashing
Alarm display	LED yellow flashing

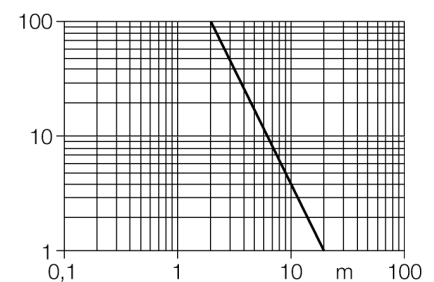

**Photoelectric sensor  
opposed mode sensor (receiver)  
S18SN6RQ**

**TURCK**

Industrial  
Automation

**Accessories**

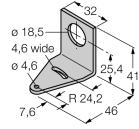
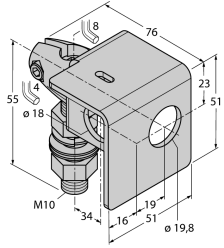
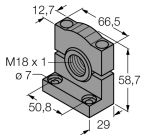
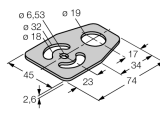
Type code	Ident no.	Description	Dimension drawing
SMB18A	3033200	Mounting bracket, stainless steel, for sensors with 18 mm thread	
SMB18AFAM10	3012558	Mounting bracket, material VA 1.4401, for M10 x 1.5 thread, thread length 18 mm	
SMB3018SC	3053952	Mounting bracket, PTB black, for sensors with 18 mm thread	
SMBAMS18P	3073134	Mounting bracket, stainless steel, for sensors with 18 mm thread	

**Wiring accessories**

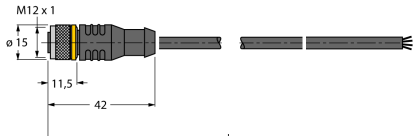
Type code	Ident no.	Description	Dimension drawing
RKC4.4T-2/TEL	6625013	Connection cable, female M12, straight, 4-pin, cable length: 2 m, sheath material: PVC, black; cULus approval; other cable lengths and qualities available, see <a href="http://www.turck.com">www.turck.com</a>	

**Photoelectric sensor  
opposed mode sensor (receiver)  
S18SN6RQ**

**Wiring accessories**

Type code	Ident no.	Description	Dimension drawing
WKC4.4T-2/TEL	6625025	Connection cable, female M12, angled, 4-pin, cable length: 2 m, sheath material: PVC, black; cULus approval; other cable lengths and qualities available, see <a href="http://www.turck.com">www.turck.com</a>	