

**Photoelectric sensor
opposed mode sensor (receiver)
T18SN6RQ**

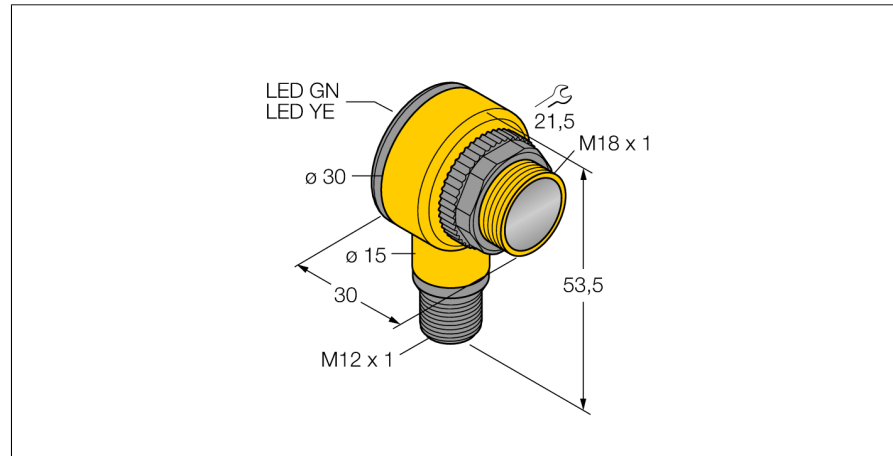

- Male M12 x 1, 5-pin
- Protection classes IP67/IP69K
- Ambient temperature: -40...+70 ° C
- Selectable light/dark operation or light operation with alarm function
- Operating voltage: 10...30 VDC
- NPN switching output, changeover

Wiring diagram

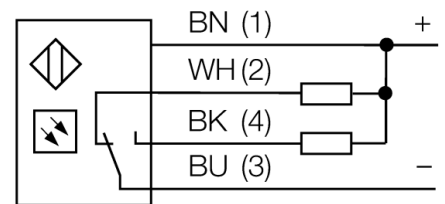

Type code	T18SN6RQ
Ident no.	3033421
Operating mode	opposed mode sensor (receiver)
Range	0...20000 mm
Ambient temperature	-40...+70 °C
Operating voltage	10...30VDC
No-load current I ₀	≤ 25 mA
Short-circuit protection	yes/ cyclic
Reverse polarity protection	yes
Output function	connection programmable, NPN
Switching frequency	≤ 160 Hz
Readiness delay	≤ 100 ms
Overcurrent release	> 220 mA
Design	cylindrical/threaded, T18
Dimensions	30 x 30 x 54 mm
Housing material	plastic, PBT
Lens	plastic, Lexan
Connection	male, M12 x 1
Protection class	IP67 / IP69K
Power-on indication	LED green
Switching state	LED yellow
Error indication	LED green flashing
Alarm display	LED yellow flashing

Functional principle

Opposed mode sensors consist of an emitter and receiver. They are installed opposite each other so that the light from the emitter is aimed directly at the receiver. When an object interrupts or weakens the light beam, the sensor switches. Opposed mode sensors are the most reliable photoelectric sensors for detection of opaque targets. An excellent contrast between light and dark conditions and an extremely high excess gain are typical of this sensing mode, thus allowing operation over larger distances and under difficult conditions.

Excess gain curve

Excess gain in relation to the distance

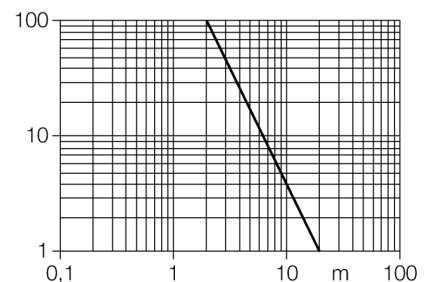

**Photoelectric sensor
opposed mode sensor (receiver)
T18SN6RQ**

TURCK

Industrial
Automation

Accessories

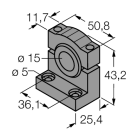
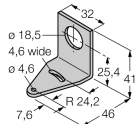
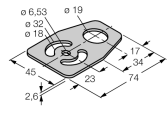
Type code	Ident no.	Description	Dimension drawing
SMB1815SF	3053279	Mounting bracket, PBT black, for PICO-GUARD points	
SMB18A	3033200	Mounting bracket, stainless steel, for sensors with 18 mm thread	
SMB18FM	3079421	mounting bracket, black, M22 x1.5 mm, male thread, female thread M18 x 1, for sensors with 18 mm thread	
SMBAMS18P	3073134	Mounting bracket, stainless steel, for sensors with 18 mm thread	

Wiring accessories

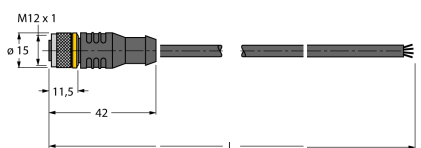
Type code	Ident no.	Description	Dimension drawing
RKC4.4T-2/TEL	6625013	Connection cable, female M12, straight, 4-pin, cable length: 2 m, sheath material: PVC, black; cULus approval; other cable lengths and qualities available, see www.turck.com	
WKC4.4T-2/TEL	6625025	Connection cable, female M12, angled, 4-pin, cable length: 2 m, sheath material: PVC, black; cULus approval; other cable lengths and qualities available, see www.turck.com	