

**Photoelectric sensor  
retroreflective sensor  
T18SN6LQ**

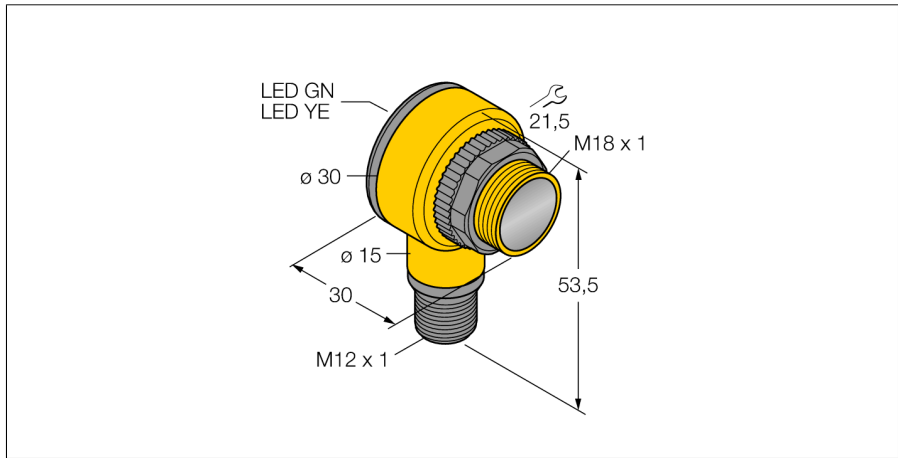

- Male M12 x 1, 5-pin
- Protection classes IP67/IP69K
- Ambient temperature: -40...+70 ° C
- Selectable light/dark operation or light operation with alarm function
- Sensitivity adjustable via potentiometer
- Operating voltage: 10...30 VDC
- NPN switching output, changeover

**Wiring diagram**

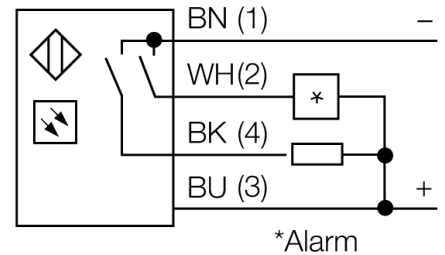
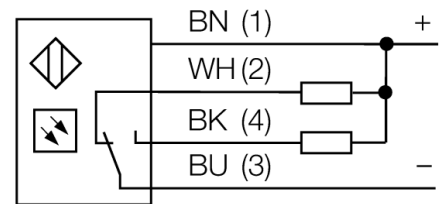

**Functional principle**

Retro-reflective sensors incorporate emitter and receiver in a single compact housing. The light beam of the emitter is directed towards a reflector which returns the light back to the receiver. An object is detected when it interrupts this beam. Retro-reflective sensors have a high function gain and good contrast performance. Further it is merely required to install and wire a single device.

**Excess gain curve**

Excess gain in relation to the distance

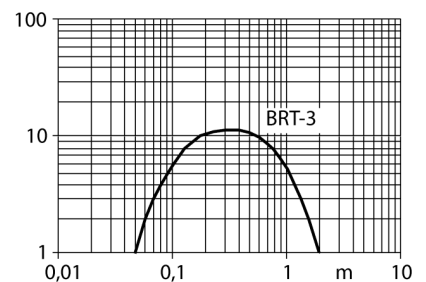

<b>Type code</b>	T18SN6LQ
Ident no.	3034739
<b>Operating mode</b>	retro-reflective sensor
Light type	IR
Wavelength	950 nm
Range	50...2000 mm
Ambient temperature	-40...+70 °C
<b>Operating voltage</b>	10...30VDC
No-load current I <sub>0</sub>	≤ 25 mA
Short-circuit protection	yes/ cyclic
Reverse polarity protection	yes
Output function	connection programmable, NPN
Switching frequency	≤ 160 Hz
Readiness delay	≤ 100 ms
Overcurrent release	> 220 mA
<b>Design</b>	cylindrical/threaded, T18
Dimensions	30 x 30 x 54 mm
Housing material	plastic, PBT
Lens	plastic, acrylic
Connection	male, M12 x 1
Protection class	IP67 / IP69K
<b>Power-on indication</b>	LED green
Switching state	LED yellow
Error indication	LED green flashing
Alarm display	LED yellow flashing

**Photoelectric sensor  
retroreflective sensor  
T18SN6LQ**

**Accessories**

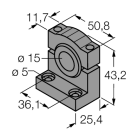
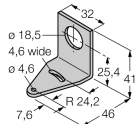
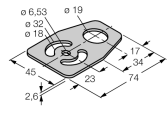
Type code	Ident no.	Description	Dimension drawing
SMB1815SF	3053279	Mounting bracket, PBT black, for PICO-GUARD points	
SMB18A	3033200	Mounting bracket, stainless steel, for sensors with 18 mm thread	
SMB18FM	3079421	mounting bracket, black, M22 x1.5 mm, male thread, female thread M18 x 1, for sensors with 18 mm thread	
SMBAMS18P	3073134	Mounting bracket, stainless steel, for sensors with 18 mm thread	

**Wiring accessories**

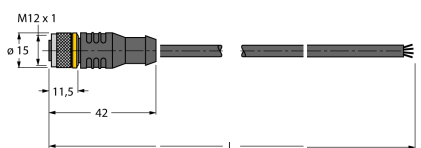
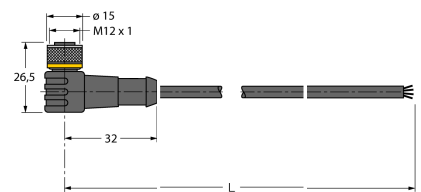
Type code	Ident no.	Description	Dimension drawing
RKC4.4T-2/TEL	6625013	Connection cable, female M12, straight, 4-pin, cable length: 2 m, sheath material: PVC, black; cULus approval; other cable lengths and qualities available, see <a href="http://www.turck.com">www.turck.com</a>	
WKC4.4T-2/TEL	6625025	Connection cable, female M12, angled, 4-pin, cable length: 2 m, sheath material: PVC, black; cULus approval; other cable lengths and qualities available, see <a href="http://www.turck.com">www.turck.com</a>	

Photoelectric sensor  
retroreflective sensor  
T18SN6LQ

**TURCK**

Industrial  
Automation

Function accessories

Type code	Ident no.	Description	Dimension drawing
BRT-3	3016164	Round reflector, reflection coefficient 1.0, material acrylic, ambient temperature -20 ... +60 °C	