

**Photoelectric sensor
retroreflective sensor
Q45AD9LVQ**

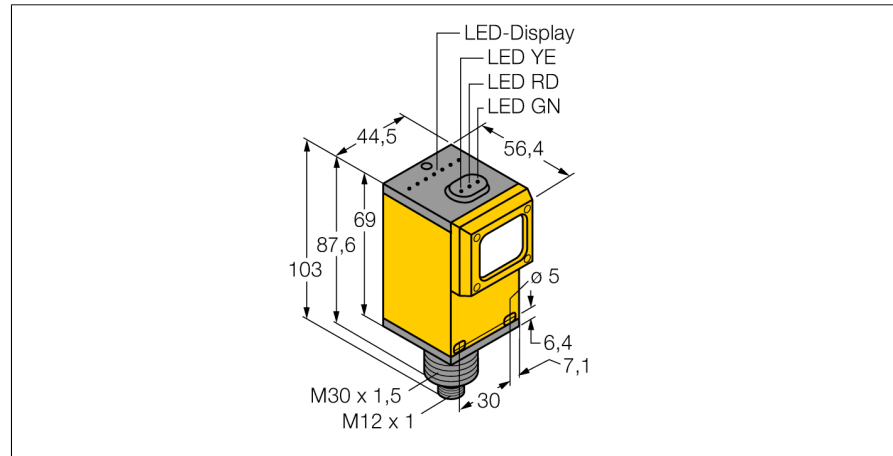

- ATEX category II 1 G, Ex zone 0
- Male M12 x 1
- Protection class IP67
- Sensitivity adjusted via potentiometer
- Operating voltage: 5...15 VDC
- NAMUR output: dark ≤ 1.2 mA ; light ≥ 2.1 mA
- Acc. to EN 60947-5-6 (NAMUR)

Wiring diagram

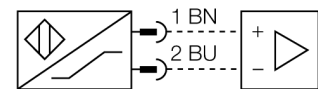

Type code	Q45AD9LVQ
Ident no.	3037630
Operating mode	retro-reflective sensor
Light type	red
Wavelength	680 nm
Range	80...9000 mm
Ambient temperature	-40...+70 °C
Voltage	Nom. 8.2 VDC
Non-actuated current consumption	≤ 1 mA
Actuated current consumption	≥ 2.1 mA
No-load current I_0	≤ 2.1 mA
Output function	light operation, NAMUR
Switching frequency	≤ 100 Hz
Device designation	Ex II 1 G Ex ia IIC T5
Design	rectangular, Q45
Dimensions	54.1 x 44.5 x 102.6 mm
Housing material	plastic, PBT
Lens	plastic, acrylic
Connection	male, M12 x 1
Protection class	IP67
MTTF	67 years acc. to SN 29500 (Ed. 99) 40 °C
Protection type	Ex ia IIC T6
Ex approval acc. to conformity certificate	KEMA 03ATEX 1441 X
Switching state	LED red

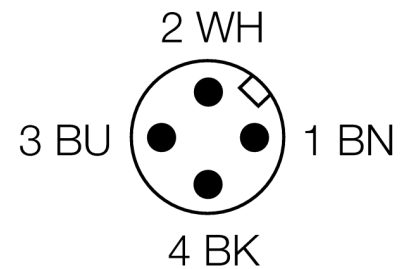

Functional principle

Retro-reflective sensors incorporate emitter and receiver in a single compact housing. The light beam of the emitter is directed towards a reflector which returns the light back to the receiver. An object is detected when it interrupts this beam. Retro-reflective sensors incorporate some of the advantages of opposed mode sensors (good contrast and high excess gain). Further it is merely required to install and wire a single device. A smaller sensing range and susceptibility of devices without polarisation filter can be of disadvantage when shiny objects have to be detected.

Excess gain curve

Excess gain in relation to the distance

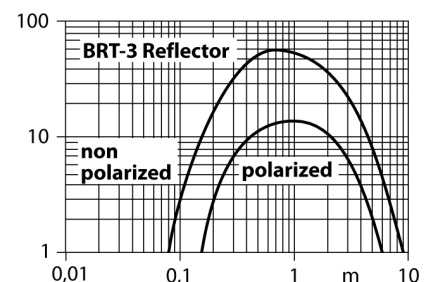

Photoelectric sensor
retroreflective sensor
Q45AD9LVQ

TURCK

Industrial
Automation

Accessories

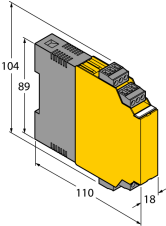
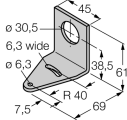
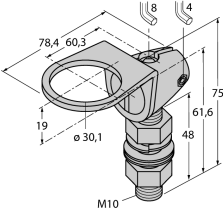
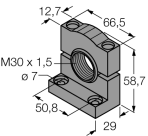
Type code	Ident no.	Description	Dimension drawing
IM1-22EX-R/24VDC	7541210	isolating switching amplifier, two channels; input for NAMUR signals; optional wire-break and short-circuit monitoring function; selectable normally open or normally closed performance; removable terminal blocks; 18 mm wide; supply voltage 24 VDC	
SMB30A	3032723	Mounting bracket, stainless steel, for sensors with 30 mm thread	
SMB30FAM10	3011185	Mounting bracket, stainless steel, for M10 x 1.5 thread, thread length 30 mm	
SMB30SC	3052521	Mounting bracket, PBT black; for 30 mm thread; with 4 screws M5 x 0.8	

Photoelectric sensor retroreflective sensor Q45AD9LVQ

TURCK

Industrial
Automation

Operating manual

Intended use

This device fulfills the directive 94/9/EC and is suited for use in explosion hazardous areas according to EN60079-0:2009, -11:2012, -26:2007. In order to ensure correct operation to the intended purpose it is required to observe the national regulations and directives.

For use in explosion hazardous areas conform to classification

II 1 G (Group II, Category 1 G, electrical equipment for gaseous atmospheres).

Marking (see device or technical data sheet)

Ex II 1 G and Ex ia IIC T5 acc. to EN60079-0, -11 and -26

Local admissible ambient temperature

-25...+70 °C

Installation / Commissioning

These devices may only be installed, connected and operated by trained and qualified staff. Qualified staff must have knowledge of protection classes, directives and regulations concerning electrical equipment designed for use in explosion hazardous areas.

Please verify that the classification and the marking on the device comply with the actual application conditions.

This device is only suited for connection to approved Exi circuits compliant to EN60079-0 and -11. Please observe the maximum admissible electrical values.

After connection to other circuits the sensor may no longer be used in Exi installations. When interconnected to (associated) electrical equipment, it is required to perform the "Proof of intrinsic safety" (EN60079-14).

Installation and mounting instructions

Avoid static charging of cables and plastic devices. Please only clean the device with a damp cloth. Do not install the device in a dust flow and avoid build-up of dust deposits on the device.

If the devices and the cable could be subject to mechanical damage, they must be protected accordingly. They must also be shielded against strong electro-magnetic fields.

The pin configuration and the electrical specifications can be taken from the device marking or the technical data sheet.

In order to avoid contamination of the device, please remove possible blanking plugs of the cable glands or connectors only shortly before inserting the cable or opening the cable socket.

service / maintenance

Repairs are not possible. The approval expires if the device is repaired or modified by a person other than the manufacturer. The most important data from the approval are listed.