

**Photoelectric sensor
retroreflective sensor with polarizing filter
S30SN6LP**

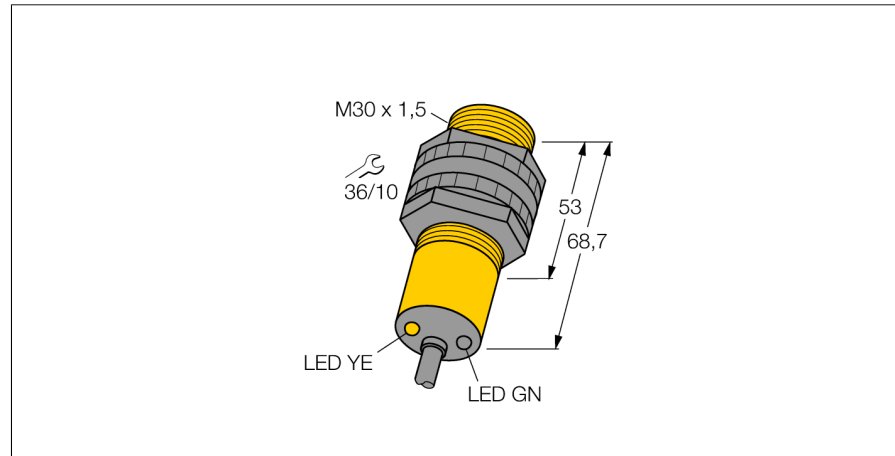

- Cable, 2 m
- Protection class IP67
- Ambient temperature: -40...+70 °C
- Operating voltage: 10...30 VDC
- NPN switching output, changeover

Wiring diagram

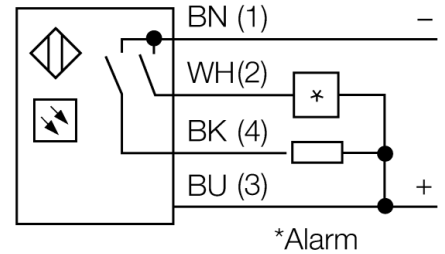

Functional principle

Retro-reflective sensors incorporate emitter and receiver in a single compact housing. The light beam of the emitter is directed towards a reflector which returns the light back to the receiver. An object is detected when it interrupts this beam. Retro-reflective sensors have a high function gain and good contrast performance. Further it is merely required to install and wire a single device.

Excess gain curve

Excess gain in relation to the distance

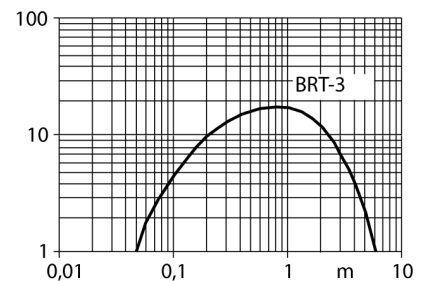

Type code	S30SN6LP
Ident no.	3032326
Operating mode	retro-reflective sensor with polarisation filter
Light type	red
Wavelength	680 nm
Range	50...6000 mm
Ambient temperature	-40...+70 °C
Operating voltage	10...30VDC
No-load current I ₀	≤ 30 mA
Short-circuit protection	yes/ cyclic
Reverse polarity protection	yes
Output function	connection programmable, NPN
Switching frequency	≤ 160 Hz
Readiness delay	≤ 100 ms
Overcurrent release	> 220 mA
Design	cylindrical/threaded, S30
Dimensions	68.7 mm
Housing diameter	30 mm
Housing material	plastic, PBT
Lens	plastic, acrylic
Connection	cable
Cable length	2 m
Cable cross section	4 x 0.5 mm ²
Protection class	IP67
Power-on indication	LED green
Switching state	LED yellow
Error indication	LED green flashing
Alarm display	LED yellow flashing

**Photoelectric sensor
retroreflective sensor with polarizing filter
S30SN6LP**

TURCK

Industrial
Automation

Accessories

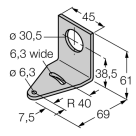
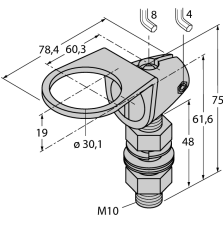
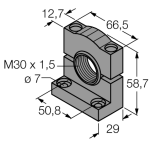
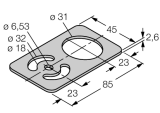
Type code	Ident no.	Description	Dimension drawing
SMB30A	3032723	Mounting bracket, stainless steel, for sensors with 30 mm thread	
SMB30FAM10	3011185	Mounting bracket, stainless steel, for M10 x 1.5 thread, thread length 30 mm	
SMB30SC	3052521	Mounting bracket, PBT black; for 30 mm thread; with 4 screws M5 x 0.8	
SMBAMS30P	3073135	Mounting bracket, stainless steel, for sensors with 30 mm thread	

Function accessories

Type code	Ident no.	Description	Dimension drawing
BRT-3	3016164	Round reflector, reflection coefficient 1.0, material acrylic, ambient temperature -20 ... +60 °C	