

**Photoelectric sensor  
retroreflective sensor with polarizing filter  
S18SN6LPQ**

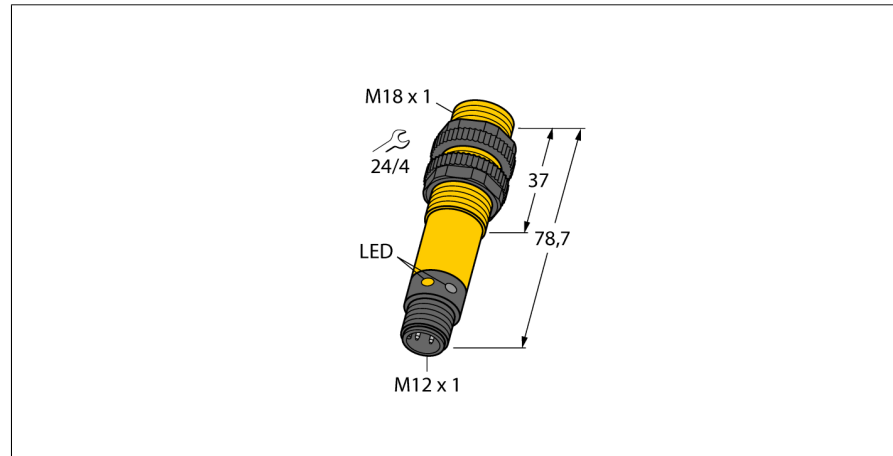

- Male M12 x 1, 5-pin
- Protection classes IP67/IP69K
- Ambient temperature: -40...+70 ° C
- Selectable light/dark operation or light operation with alarm function
- Operating voltage: 10...30 VDC
- NPN switching output, changeover

**Wiring diagram**

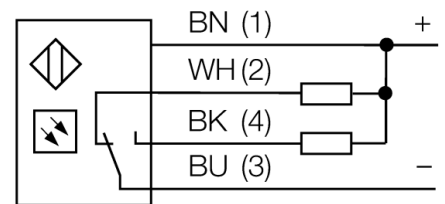

**Functional principle**

Retro-reflective sensors incorporate emitter and receiver in a single compact housing. The light beam of the emitter is directed towards a reflector which returns the light back to the receiver. An object is detected when it interrupts this beam. Retro-reflective sensors have a high function gain and good contrast performance. Further it is merely required to install and wire a single device.

**Excess gain curve**

Excess gain in relation to the distance

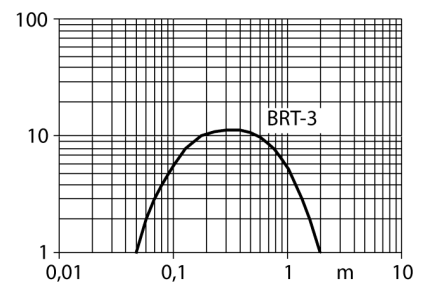

<b>Type code</b>	S18SN6LPQ
Ident no.	3033449
<b>Operating mode</b>	retro-reflective sensor with polarisation filter
Light type	red
Wavelength	680 nm
Range	50...2000 mm
Ambient temperature	-40...+70 °C
<b>Operating voltage</b>	10...30VDC
No-load current I <sub>0</sub>	≤ 30 mA
Short-circuit protection	yes/ cyclic
Reverse polarity protection	yes
Output function	connection programmable, NPN
Switching frequency	≤ 160 Hz
Readiness delay	≤ 100 ms
Overcurrent release	> 220 mA
<b>Design</b>	cylindrical/threaded, S18
Dimensions	78.7 mm
Housing diameter	18 mm
Housing material	plastic, PBT
Lens	plastic, acrylic
Connection	male, M12 x 1
Protection class	IP67 / IP69K
<b>Power-on indication</b>	LED green
Switching state	LED yellow
Error indication	LED green flashing
Alarm display	LED yellow flashing

**Photoelectric sensor  
retroreflective sensor with polarizing filter  
S18SN6LPQ**

**Accessories**

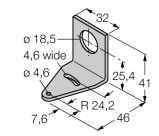
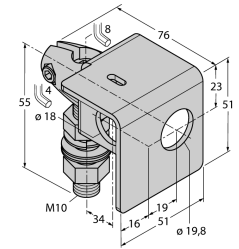
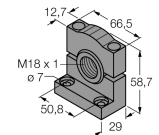
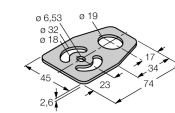
Type code	Ident no.	Description	Dimension drawing
SMB18A	3033200	Mounting bracket, stainless steel, for sensors with 18 mm thread	
SMB18AFAM10	3012558	Mounting bracket, material VA 1.4401, for M10 x 1.5 thread, thread length 18 mm	
SMB3018SC	3053952	Mounting bracket, PTB black, for sensors with 18 mm thread	
SMBAMS18P	3073134	Mounting bracket, stainless steel, for sensors with 18 mm thread	

**Wiring accessories**

Type code	Ident no.	Description	Dimension drawing
RKC4.4T-2/TEL	6625013	Connection cable, female M12, straight, 4-pin, cable length: 2 m, sheath material: PVC, black; cULus approval; other cable lengths and qualities available, see <a href="http://www.turck.com">www.turck.com</a>	

**Photoelectric sensor  
retroreflective sensor with polarizing filter  
S18SN6LPQ**

**Wiring accessories**

Type code	Ident no.	Description	Dimension drawing
WKC4.4T-2/TEL	6625025	Connection cable, female M12, angled, 4-pin, cable length: 2 m, sheath material: PVC, black; cULus approval; other cable lengths and qualities available, see <a href="http://www.turck.com">www.turck.com</a>	

**Function accessories**

Type code	Ident no.	Description	Dimension drawing
BRT-3	3016164	Round reflector, reflection coefficient 1.0, material acrylic, ambient temperature -20 ... +60 °C	