

Photoelectric sensor
Retroreflective sensor with polarizing filter
S18-2VPLP-2M

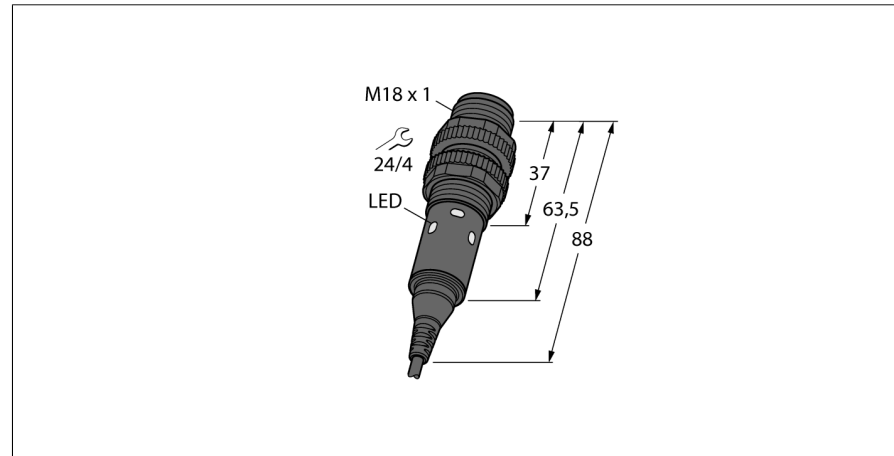

- Cable, 2 m
- Protection class IP67
- Ambient temperature: -40...+70 °C
- Selectable light/dark operation or light operation with alarm function
- Operating voltage: 10...30 VDC
- PNP switching output, changeover

Wiring diagram



Functional principle

Retroreflective sensors have emitter and receiver incorporated in the same housing. The light beam of the emitter is directed towards a reflector which returns the light back to the receiver. A target is detected when it interrupts this beam. Retroreflective sensors have a high function gain and good contrast performance. Furthermore, only one device has to be installed and wired.

Excess gain curve

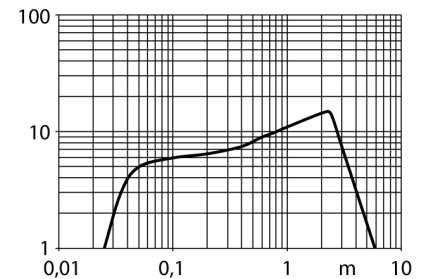

Type code	S18-2VPLP-2M
Ident no.	3042145
Operating mode	retro-reflective sensor with polarisation filter
Light type	red
Wavelength	624 nm
Range	150...6000 mm
Ambient temperature	-40...+70 °C
Operating voltage	10...30VDC
Residual ripple	< 10 % U _s
No-load current I ₀	≤ 16 mA
Short-circuit protection	yes/ cyclic
Reverse polarity protection	yes
Output function	changover contact, PNP
Readiness delay	≤ 100 ms
Response time	< 2.25 ms
Design	cylindrical/threaded, S18
Dimensions	88 mm
Housing diameter	18 mm
Housing material	plastic, ABS
Connection	cable
Cable length	2 m
Cable cross section	4 x 0.5 mm ²
Protection class	IP67
Power-on indication	LED green
Switching state	LED yellow

**Photoelectric sensor
Retroreflective sensor with polarizing filter
S18-2VPLP-2M**

Accessories

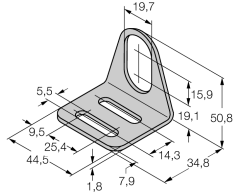
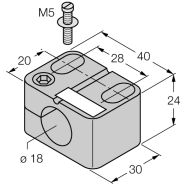
Type code	Ident no.	Description	Dimension drawing
MW-18	6945004	Mounting bracket for threaded barrel devices; material: Stainless steel A2 1.4301 (AISI 304)	
BST-18N	6947215	Fixing clamp for threaded barrel devices, without dead-stop; material: PA6	

Wiring accessories

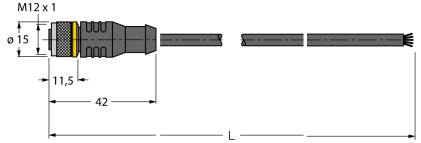
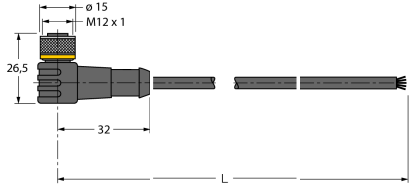
Type code	Ident no.	Description	Dimension drawing
RKC4.5T-2/TEL	6625016	Connection cable, female M12, straight, 5-pin, cable length: 2 m, sheath material: PVC, black; cULus approval; other cable lengths and qualities available, see www.turck.com	
WKC4.5T-2/TEL	6625028	Connection cable, female M12, angled, 5-pin, cable length: 2 m, sheath material: PVC, black; cULus approval; other cable lengths and qualities available, see www.turck.com	

Function accessories

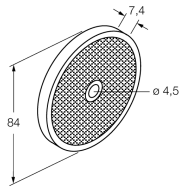
Type code	Ident no.	Description	Dimension drawing
BRT-84	3058979	Round reflector, reflection coefficient 1.4, material acrylic, ambient temperature -20 ... +60 °C	

**Photoelectric sensor
Retroreflective sensor with polarizing filter
S18-2VPLP-2M**

Function accessories

Type code	Ident no.	Description	Dimension drawing
BRT-60X40C	3044997	Rectangular reflector, reflection coefficient 1.48, material: acrylic, ambient temperature -20...+60 °C	