

**Photoelectric sensor
retroreflective sensor
laser running time meter
LT3PULV**



- Cable, 2 m, 7-wire
- Indication of signal intensity
- Protection class IP67
- BRT-TVHG-8X10P highly reflective foil, incl. in delivery
- Measuring range with according reflector foil: 50 m
- 3 response times adjustable for switching output
- Operating voltage: 12...24 VDC
- Hysteresis and measuring range independently adjustable
- Edge of the analog output invertible

Type code	LT3PULV
Ident no.	3067273
Operating mode	Retroreflective laser sensor (time-of-flight)
Light type	red
Wavelength	658 nm
Laser class	▲ 1
Repeatability	4.5 mm
Range	500...50000 mm
Ambient temperature	0...+50 °C
Operating voltage	12...24VDC
Residual ripple	< 10 % U _s
DC rated operational current	≤ 100 mA
No-load current I ₀	≤ 108 mA
Short-circuit protection	yes
Reverse polarity protection	yes
Output function	NO contact, PNP/analog output
Voltage output	0...10V
Load resistance	≥ 2500 Ω
Switching frequency	≤ 1000 Hz
Readiness delay	≤ 1 s
Design	rectangular, LT3
Dimensions	87 x 35.3 x 68.5 mm
Housing material	plastic, ABS, black
Lens	plastic, acrylic
Connection	cable, PVC
Cable length	2 m
Cable cross section	7 x 0.34 mm ²
Protection class	IP67
MTTF	15 years acc. to SN 29500 (Ed. 99) 40 °C
Power-on indication	LED green
Switching state	LED yellow
Error indication	LED
Excess gain indication	LED red

Wiring diagram

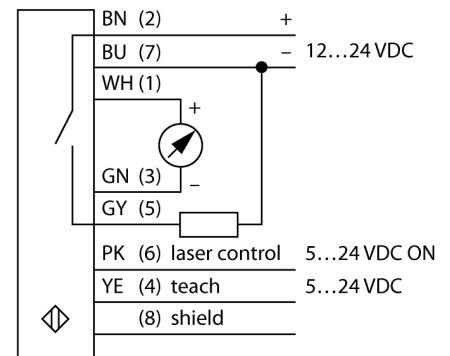

Functional principle

This distance sensor uses pulsed time-of-flight technology and is thus extremely powerful. The laser pulses one million times per second. The microprocessor records the time required for each pulse to travel to the object and back to the sensor. Every millisecond, one thousand pulse times are averaged and the corresponding value is transferred to the output.

The sensor achieves its highest accuracy after a 30-min. warm-up period.

Resolution versus distance

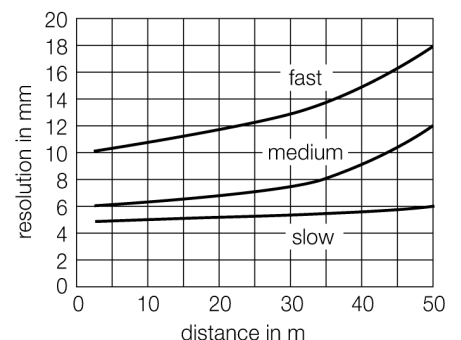

**Photoelectric sensor
retroreflective sensor
laser running time meter
LT3PULV**

Accessories

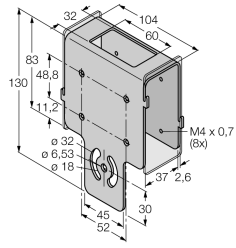
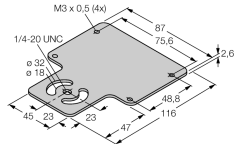
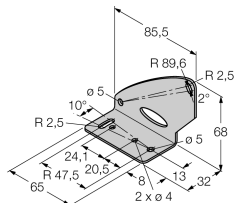
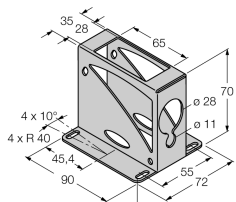
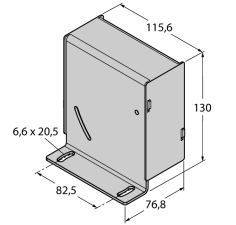
Type code	Ident no.	Description	Dimension drawing
SMBAMSLT3IP	3073442	Protective housing with safety glas panel, for LT3 series	
SMBAMSLT3P	3073132	Backplane, stainless steel, for LT3 series	
SMBLT31	3068505	Mounting bracket, stainless steel, for LT3 series	
SMBLT32	3069236	Protective housing, stainless steel, for LT3 series	
SMBLT3IP	3070973	Protective housing, stainless steel, for LT3 series	

Function accessories

Type code	Ident no.	Description	Dimension drawing
BRT-TVHG-8X10P	3069119	Reflective foil, self-adhesive, cuttable, highly reflective, 203 x 254 mm	