

Inductive linear position sensor
LI800P0-Q25LM0-ESG25X3-H1181

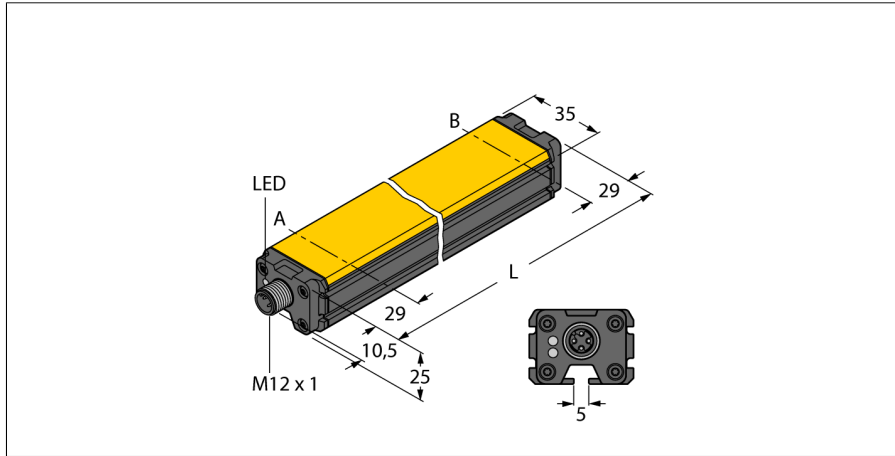

- Rectangular, aluminium / plastic
- Versatile mounting possibilities
- Measuring range indicated via LED
- Immune to electromagnetic interferences.
- Extremely short blind zones
- Resolution 0,001 mm
- 15...30 VDC
- Male M12 x 1, 8-pin
- SSI output
- 25 bit, Gray-coded
- SSI clock rate: 62.5 kHz ... 1 MHz

Type code	LI800P0-Q25LM0-ESG25X3-H1181
Ident no.	1590015
Measuring range [A...B]	800mm
Resolution	0,001 mm
blind zone a	29 mm
blind zone b	29 mm
Reproducibility	≤ 10 µm
Linearity deviation	≤ 0.035 %
Temperature drift	≤ ± 0.0001 % / K
Ambient temperature	-25...+70 °C
Operating voltage	15...30VDC
Residual ripple	≤ 10 % U _{ss}
No-load current I ₀	≤ 50 mA
Rated insulation voltage	≤ 0.5 kV
Short-circuit protection	yes
Wire breakage / Reverse polarity protection	yes/ yes (voltage supply)
Output function	8-wire, SSI, 25 Bit, Gray coded
Process data area	Bit 0 ... Bit 19
Diagnostic bits	Bit 21: Positioning element left the measuring range and is outside the detectable area. Bit 22: Positioning element is in the measuring range, lower signal quality (e.g. distance too large) Bit 23: Positioning element is outside the measuring range
Sample rate	1000 Hz
Design	rectangular, Q25L
Dimensions	858 x 35 x 25 mm
Housing material	aluminium
Material active area	Plastic, FRIANYL B63V0GV
Connection	male, M12 x 1
Vibration resistance	55 Hz (1 mm)
Shock resistance	30 g (11 ms)
Protection class	IP67
MTTF	138 years acc. to SN 29500 (Ed. 99) 40 °C
Power-on indication	LED green
Measuring range display	multifunction LED, green, yellow, yellow flashing

Wiring diagram

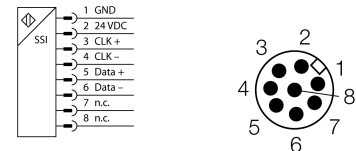

Functional principle

The measuring principle of inductive angle sensors is based on oscillation circuit coupling between the positioning element and the sensor. The output signal provided is proportional to the angle of the positioning element. The rugged sensors are wear and maintenance-free, thanks to the contactless operating principle. They convince through their excellent repeatability, resolution and linearity within a broad temperature range. Thanks to the innovative technology, electromagnetic AC and DC fields have no influence on the measured signal.

Inductive linear position sensor LI800P0-Q25LM0-ESG25X3-H1181

TURCK

Industrial
Automation

Mounting instructions / Description



A broad range of accessories allows the device to be mounted in many different ways. Based on the functional principle of RLC coupling, the sensor is immune to magnetized metal splinters and other interferences.

LED indications:

green steady:

Positioning element is in the measuring range

yellow steady:

Positioning element has reached the end of the measuring range. This is indicated by a lower signal quality, see status bit 22.

yellow flashing:

Positioning element is outside the coverage, see status bit 23

off:

Positioning element is outside the programmed measuring range (only with teachable versions)



Inductive linear position sensor
LI800P0-Q25LM0-ESG25X3-H1181

TURCK

Industrial
Automation

Accessories

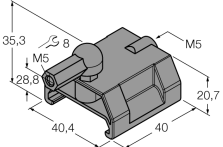
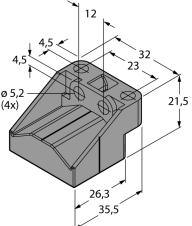
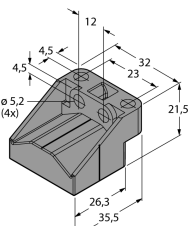
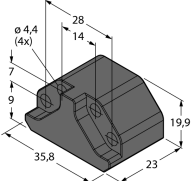
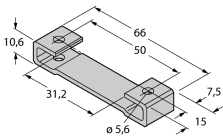
Type code	Ident no.	Description	Dimension drawing
P1-Li-Q25L	6901041	Guided positioning element for Li-Q25L, inserted in the sensor guide.	
P2-Li-Q25L	6901042	Floating positioning element for Li-Q25L; The nominal distance to the sensor is 2 mm; Pairing with the linear position sensor at a distance of up to 5 mm; Misalignment tolerance of up to 4 mm.	
P3-Li-Q25L	6901044	Floating positioning element for Li-Q25L; Operational at an offset of 90°; Nominal distance to sensor 2 mm; Pairing with linear position sensor at a distance of up to 5 mm; misalignment tolerance of up to 4 mm.	
P6-Li-Q25L	6901069	Floating positioning element for Li-Q25L; The nominal distance to the sensor is 2 mm; Pairing with the linear position sensor at a distance of up to 5 mm; Misalignment tolerance of up to 4 mm.	
M1-Q25L	6901045	Mounting foot for linear position sensor Q25L; aluminium; 2 pcs. per bag	

Inductive linear position sensor
LI800P0-Q25LM0-ESG25X3-H1181

TURCK

Industrial
Automation

Accessories

Type code	Ident no.	Description	Dimension drawing
M2-Q25L	6901046	Mounting foot for linear position sensor Q25L; aluminium; 2 pcs. per bag	
M4-Q25L	6901048	Mounting bracket for linear position sensor Q25L; material Stainless steel; 2 pcs. per bag	
MN-M4-Q25	6901025	Sliding block with M4 thread for the backside profile of the Q25L; material Brass; 10 pcs. per bag	
AB-M5	6901057	Axial joint for Li-Q25L specific guided positioning elements	
ABVA-M5	6901058	Axial joint for guided positioning element, stainless steel	

Inductive linear position sensor
LI800P0-Q25LM0-ESG25X3-H1181

TURCK

Industrial
Automation

Accessories

Type code	Ident no.	Description	Dimension drawing
RBVA-M5	6901059	Angle joint for guided positioning element, stainless steel	