

**Inductive linear position sensor**  
**Li300P1-Q17LM1-LU4X2-0,3-RS5/S97**

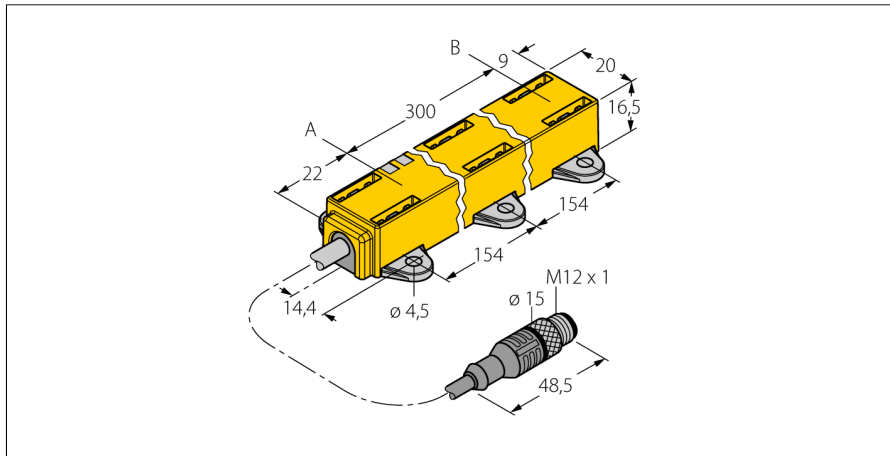

- Rectangular, plastic
- Many mounting possibilities
- Positioning element P1-Li-QR14/Q17L, mounting aids M1.1-Q17L and M1.2-Q17L included in delivery
- LED indicates measuring range
- Immune to electromagnetic interferences
- Extremely short blind zones
- 12 bit resolution
- 4-wire, 8...30 VDC
- Analog output
- Programmable measuring range
- 0.5...4.5 V
- Cable with male end M12 x 1

<b>Type code</b>	Li300P1-Q17LM1-LU4X2-0,3-RS5/S97
<b>Ident no.</b>	1590758
<b>Measuring range [A...B]</b>	300mm
Resolution	0,073 mm/12 bit
blind zone a	22 mm
blind zone b	9 mm
Linearity deviation	≤ 0.5 %
Temperature drift	≤ ± 0.01 % / K
Ambient temperature	-40...+70 °C
<b>Operating voltage</b>	8...30VDC
Residual ripple	≤ 10 % U <sub>ss</sub>
No-load current I <sub>0</sub>	≤ 50 mA
Rated insulation voltage	≤ 0.5 kV
Short-circuit protection	yes
Wire breakage / Reverse polarity protection	yes/ yes (voltage supply)
Output function	3-wire, analog output
Voltage output	0.5...4.5V
Load resistance voltage output	≥ 4.7 kΩ
Sample rate	500 Hz
<b>Design</b>	rectangular, Q17L
Dimensions	331 x 20 x 16.5 mm
Housing material	plastic, PC-GF10
Connection	cable with connector, M12 x 1
Cable quality	5 mm, Lif32Y32Y, TPE, 0.3 m Low temp. flexible and E-chain capable
Cable cross section	4 x 0.34 mm <sup>2</sup>
Vibration resistance	55 Hz (1 mm)
Shock resistance	30 g (11 ms)
Protection class	IP67
MTTF	138 years acc. to SN 29500 (Ed. 99) 40 °C
<b>Power-on indication</b>	LED green
Measuring range display	multifunction LED, green
Included in scope of supply	positioning element P1-Li-QR14/Q17L, M1.1-Q17L, M1.2-Q17L

**Wiring diagram**

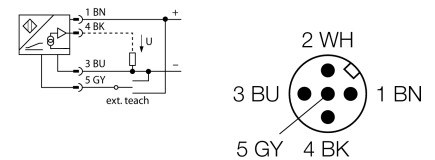

**Functional principle**

The measuring principle of inductive angle sensors is based on oscillation circuit coupling between the positioning element and the sensor. The output signal provided is proportional to the angle of the positioning element. The rugged sensors are wear and maintenance-free, thanks to the contactless operating principle. They convince through their excellent repeatability, resolution and linearity within a broad temperature range. Thanks to the innovative technology, electromagnetic AC and DC fields have no influence on the measured signal.

**Characteristic**

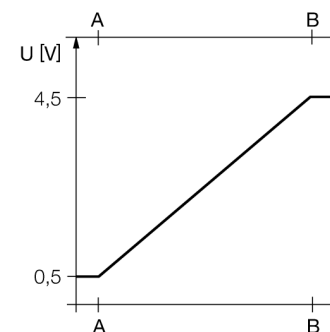

# Inductive linear position sensor Li300P1-Q17LM1-LU4X2-0,3-RS5/S97

**TURCK**

Industrial  
Automation

## Mounting instructions / Description



A broad range of accessories allows the device to be mounted in many different ways.

The positioning element can be mounted offset by 90°. This provides highest mounting flexibility. The linear position sensor can also be mounted offset by 90° with the two provided fittings. Based on the functional principle of RLC coupling, the sensor is immune to magnetized metal splinters and other interferences.

### LED indications:

#### green steady:

Positioning element is in the measuring range

#### green flashing:

Positioning element has reached the end of the measuring range. This is indicated by a weaker signal.

#### off:

Positioning element is outside the coverage.

### TEACH process

The start and end value of the measuring range are set via teach adapter at the touch of a button. Moreover the output curve can be inverted.

Bridge pin 5 and pin 1 for 10 s = factory setting

Bridge pin 5 and pin 3 for 10 s = factory setting inverted

Bridge pin 5 and pin 3 for 2 s = sets start value of measuring range

Bridge pin 5 and pin 1 for 2 s = sets end value of measuring range

**Inductive linear position sensor**  
**Li300P1-Q17LM1-LU4X2-0,3-RS5/S97**

**Accessories**

Type code	Ident no.	Description	Dimension drawing
P1-Li-QR14/Q17L	1590724	Floating positioning element; cross and longitudinal mounting	
M1.1-Q17L	1590749	Mounting bracket for linear position sensor Q17L; aluminium; 3 pcs. per bag	
M1.2-Q17L	1590750	Mounting foot for linear position sensor Q17L; aluminium; 3 pcs. per bag	
RMT-Q17L	1590755	Removal tool for mounting elements for linear position sensor Q17L	
TX1-Q20L60	6967114	Teach adapter for inductive encoders, linear position, angle and ultrasonic sensors	