

Rotative measurement
Absolute rotary encoder / Multiturn
RM-28S6C-3C25B-H1181

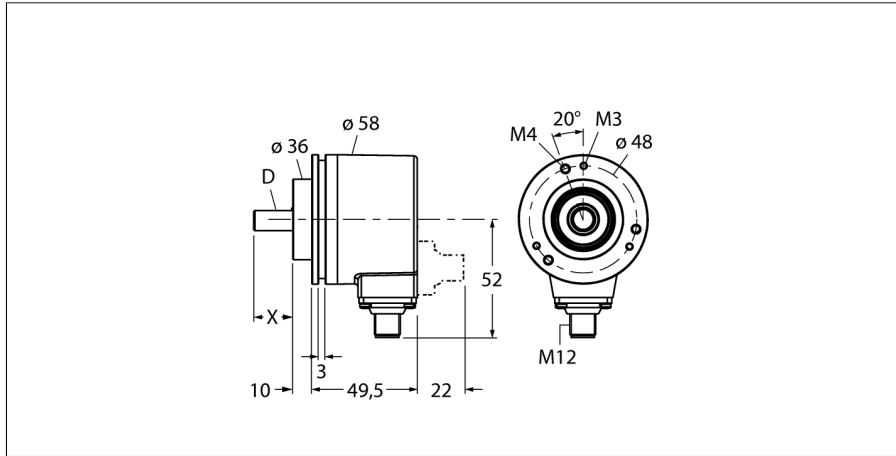

- Clamping flange, Ø 58 mm
- Solid shaft, Ø 6 mm x 10 mm
- Optical measuring principle
- Shaft material: stainless steel
- Protection class IP67 on the shaft side
- -40...+70°C
- max. 9000 rev/min
- 10...30 VDC
- SSI, gray
- Male connector, M12 x 1, 8-pole
- Singleturn, 13 bit resolution
- Multiturn, 12 bit resolution

Type code	RM-28S6C-3C25B-H1181
Ident no.	1545238
Measuring principle	Photoelectric
max. Drehzahl	9.000 U/min
Moment of inertia of the rotor	4 x10 ⁻⁶ kgm ²
Starting torque	0.01 Nm
Ambient temperature	-40...+70 °C
Operating voltage	10...30VDC
No-load current I ₀	≤ 50 mA
Output current	≤ 20 mA
Short-circuit protection	yes
Output function	8-wire, SSI, Gray coded
Output type	absolute multiturn
Resolution single-turn	13 Bit
Resolution multiturn	12 Bit
Signal level high	typ. 3.8 V
Signal level low	typ. 1.3 V
Design	Solid shaft
Flange type	Clamping flange
Flange diameter	58 mm
Shaft type	Shaft
Shaft diameter D	6 mm
Shaft length X	10 mm
Shaft material	Stainless steel
Housing material	zinc, die-casting
Connection	male, M12 x 1 M12, 8-pole
Axial shaft load	40 N
Radial shaft load	80 N
Vibration resistance (EN 60068-2-6)	100 m/s ² , 55...2000 Hz
Shock resistance (EN 60068-2-27)	2500 m/s ² , 6 ms
Protection class housing	IP67
Protection class shaft	IP67

1	GND	
2	U _B	+
3	C	+
4	C	-
5	D	+
6	D	-
7	SET	
8	DIR	
PH	shield/PE	

**Rotative measurement
Absolute rotary encoder / Multiturn
RM-28S6C-3C25B-H1181****Pin configuration**

Signal	Gnd	+U _e	C+	C-	D+	D-	SET	DIR	Shield / PE
Pin configuration	1	2	3	4	5	6	7	8	PH

Rotative measurement
Absolute rotary encoder / Multiturn
RM-28S6C-3C25B-H1181

Accessories

Type code	Ident no.	Description	Dimension drawing
RFA-2	1544631	Aluminium flange adapter, rectangular, for solid shaft encoders with clamping flange; edge length 63.5mm; 3mm thick	
RFA-4	1544633	Euro flange – aluminium flange adapter for solid shaft encoders, Ø 115 mm; reference diameter 100 mm; adapts 58 mm clamping flange to Euro flange	
RFA-6	1544635	Aluminium flange adapter for solid shaft encoders with clamping flange, Ø 58 mm; adapts clamping flange to synchro flange	
RFA-7	1544636	Aluminium flange adapter for solid shaft encoders, Ø 65 mm; adapts to Ø 65 mm flange and 48 mm reference diameter	
RFA-8	1544637	Aluminium flange adapter for solid shaft encoders with clamping flange, Ø 70 mm; thickness 4 mm, adapts to Ø 70 mm flange	

Rotative measurement
Absolute rotary encoder / Multiturn
RM-28S6C-3C25B-H1181

Accessories

Type code	Ident no.	Description	Dimension drawing
RFA-9	1544638	Aluminium angle flange for solid shaft encoders with Ø 58 mm clamping flange	
RFA-11	1544640	Aluminium flange adapter for solid shaft encoders with clamping flange, Ø 70 mm; thickness 10mm, adapts to Ø 70 mm flange	
RFA-12	1544641	Aluminium flange adapter, rectangular, for solid shaft encoders with clamping flange; edge length 70mm; 10mm thick	
RFA-13	1544642	Aluminium flange adapter, rectangular, for solid shaft encoders with clamping flange; edge length 80mm; 4 mm thick	
RFA-1	1544630	Aluminium flange adapter, rectangular, for solid shaft encoders with clamping flange; edge length 58 mm; 4 mm thick	

Rotative measurement
Absolute rotary encoder / Multiturn
RM-28S6C-3C25B-H1181

Accessories

Type code	Ident no.	Description	Dimension drawing
RMW-1	1544643	Spring arm for encoders; max. contact pressure 40 N; for encoders with measuring wheel	
RMW-2	1544644	Aluminium measuring wheel (cross-knurled) for encoders, perimeter 0.2 m, width 12 mm, depth 10 mm	
RMW-3	1544645	Hytrel measuring wheel (smooth) for encoders, perimeter 0.2 m, width 12 mm, temp.range -10...+50°C, depth 10 mm	
RMW-4	1544646	Hytrel measuring wheel (grooved) for encoders, perimeter 0.2 m, width 12 mm, temp.range -10...+70 °C, depth 10 mm	
RMW-5	1544647	Aluminium measuring wheel (cross-knurled) for encoders, perimeter 0.5 m, width 25 mm, depth 10 mm	

Rotative measurement
Absolute rotary encoder / Multiturn
RM-28S6C-3C25B-H1181

Accessories

Type code	Ident no.	Description	Dimension drawing
RMW-6	1544648	Hytrel measuring wheel (smooth) for encoders, perimeter 0.5 m, width 25 mm, temp.range -10...+50°C, depth 10 mm	
RMW-7	1544649	Vulkollan measuring wheel (smooth) for encoders, perimeter 0.5 m, width 25 mm, temp.range -30...+80°C, depth 10 mm	
RMW-8	1544650	Aluminium measuring wheel with knobby rubber surface for encoders, perimeter 0.5 m, width 25 mm, temp.range -30...+80°C, depth 10 mm	
RMW-9	1544651	Hytrel measuring wheel (grooved) for encoders, perimeter 0.5 m, width 25 mm, temp.range -10...50 °C, depth 10 mm	