

**Rotative measurement
Incremental rotary encoder
Ri-08S6S-2F360-C 1M**

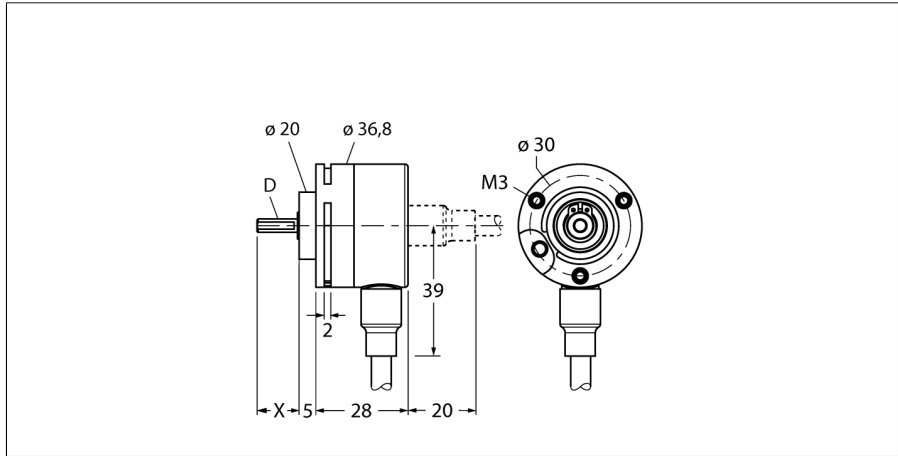

- Synchro flange, Ø 36.8mm
- Solid shaft, Ø 6mm x 12.5mm
- Optical measuring principle
- Shaft material, stainless steel
- Protection class IP65 on the shaft side
- -20 ...+70°C (supply voltage > 15 VDC: max. +55°C)
- max. 6000 rev/min
- 5...30 VDC
- Cable connection, 8-pole
- Push-pull, with inversion
- Pulse frequency max. 250kHz
- 360 pulses

Type code	Ri-08S6S-2F360-C 1M
Ident no.	1544059
Measuring principle	Photoelectric
max. Drehzahl	6.000 U/min
Moment of inertia of the rotor	0.4 x10 ⁶ kgm ²
Starting torque	0.007 Nm
Ambient temperature	-20...+70 °C
Operating voltage	5...30VDC
No-load current I ₀	≤ 100 mA
Output current	≤ 20 mA
Short-circuit protection	yes
Output function	8-wire, push-pull 7272, invertable
Output type	incremental
Resolution, incremental	360
Pulse frequency max.	250 kHz
Signal level high	min. U _s - 2 V
Signal level low	max. 0.5 V
Design	Solid shaft
Flange type	without fixing clamp
Flange diameter	36.8 mm
Shaft type	Shaft
Shaft diameter D	6 mm
Shaft length X	12.5 mm
Shaft material	Stainless steel
Housing material	plastic PPA, 40% carbon fiber
Connection	cable radial
cable length	1 m
Axial shaft load	10 N
Radial shaft load	20 N
Vibration resistance (EN 60068-2-6)	100 m/s ² , 10...2000 Hz
Shock resistance (EN 60068-2-27)	1000 m/s ² , 6 ms
Protection class housing	IP67
Protection class shaft	IP65

WH	GND	
BN	U _B	+
GN	A	
YE	A inv.	
GY	B	
PK	B inv.	
BU	0	-
RD	0 inv.	-

**Rotative measurement
Incremental rotary encoder
Ri-08S6S-2F360-C 1M**

TURCK

Industrial
Automation

Pin configuration

Signal	Gnd	+U _e	A	A inv.	B	B inv.	0	0 inv.	Shield
Core color	WH	BN	GN	YE	GY	PK	BU	RD	-

**Rotative measurement
Incremental rotary encoder
Ri-08S6S-2F360-C 1M**

Accessories

Type code	Ident no.	Description	Dimension drawing
RMW-1	1544643	Spring arm for encoders; max. contact pressure 40 N; for encoders with measuring wheel	
RMW-2	1544644	Aluminium measuring wheel (cross-knurled) for encoders, perimeter 0.2 m, width 12 mm, depth 10 mm	
RMW-3	1544645	Hytrel measuring wheel (smooth) for encoders, perimeter 0.2 m, width 12 mm, temp.range -10...+50°C, depth 10 mm	
RMW-4	1544646	Hytrel measuring wheel (grooved) for encoders, perimeter 0.2 m, width 12 mm, temp.range -10...+70 °C, depth 10 mm	
RMW-5	1544647	Aluminium measuring wheel (cross-knurled) for encoders, perimeter 0.5 m, width 25 mm, depth 10 mm	

**Rotative measurement
Incremental rotary encoder
Ri-08S6S-2F360-C 1M**

Accessories

Type code	Ident no.	Description	Dimension drawing
RMW-6	1544648	Hytrel measuring wheel (smooth) for encoders, perimeter 0.5 m, width 25 mm, temp.range -10...+50°C, depth 10 mm	
RMW-7	1544649	Vulkollan measuring wheel (smooth) for encoders, perimeter 0.5 m, width 25 mm, temp.range -30...+80°C, depth 10 mm	
RMW-8	1544650	Aluminium measuring wheel with knobby rubber surface for encoders, perimeter 0.5 m, width 25 mm, temp.range -30...+80°C, depth 10 mm	
RMW-9	1544651	Hytrel measuring wheel (grooved) for encoders, perimeter 0.5 m, width 25 mm, temp.range -10...50 °C, depth 10 mm	