

**Rotative measurement  
Incremental rotary encoder  
Ri-10S6C-2B360-H1181**

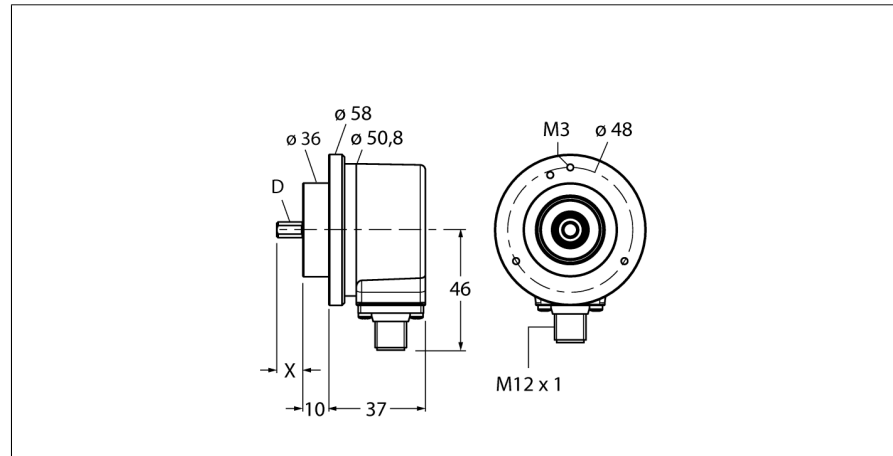

- Clamping flange, Ø 58 mm
- Solid shaft, Ø 6mm x 10mm
- Optical measuring principle
- Shaft material, stainless steel
- Protection class IP67 on the shaft side
- -40...+85°C
- Max. 6000 rev/min (continuous operation 3000 rev/min)
- 10...30 VDC
- Male connector, M12 x 1 , 8-pole
- Push-pull, with inversion
- Pulse frequency max. 300 kHz
- 360 pulses

<b>Type code</b>	Ri-10S6C-2B360-H1181
Ident no.	1544940
<b>Measuring principle</b>	Photoelectric
max. Drehzahl	6.000 U/min
Moment of inertia of the rotor	1.8 x10 <sup>-6</sup> kgm <sup>2</sup>
Starting torque	0.05 Nm
Ambient temperature	-40...+85 °C
<b>Operating voltage</b>	10...30VDC
No-load current I <sub>0</sub>	≤ 100 mA
Output current	≤ 20 mA
Short-circuit protection	yes
Output function	8-wire, push-Pull, invertable
Output type	incremental
Resolution, incremental	360
Pulse frequency max.	300 kHz
Signal level high	min. U <sub>s</sub> - 1 V
Signal level low	max. 0.5 V
<b>Design</b>	Solid shaft
Flange type	Clamping flange
Flange diameter	58 mm
Shaft type	Shaft
Shaft diameter D	6 mm
Shaft length X	10 mm
Shaft material	Stainless steel
Housing material	aluminium
Connection	male, M12 x 1 M12, 8-pole
Axial shaft load	40 N
Radial shaft load	80 N
Vibration resistance (EN 60068-2-6)	100 m/s <sup>2</sup> , 10...2000 Hz
Shock resistance (EN 60068-2-27)	2500 m/s <sup>2</sup> , 6 ms
Protection class housing	IP67
Protection class shaft	IP67

1	GND	
2	U <sub>B</sub>	+
3	A	
4	A inv.	
5	B	
6	B inv.	
7	0	-
8	0 inv.	-
PH	shield	

**Rotative measurement  
Incremental rotary encoder  
Ri-10S6C-2B360-H1181**

**TURCK**

Industrial  
Automation

**Pin configuration**

Signal	Gnd	+U <sub>e</sub>	A	A inv.	B	B inv.	0	0 inv.	Shield
Pin configuration	1	2	3	4	5	6	7	8	PH

**Rotative measurement  
Incremental rotary encoder  
Ri-10S6C-2B360-H1181**

**Accessories**

Type code	Ident no.	Description	Dimension drawing
RFA-2	1544631	Aluminium flange adapter, rectangular, for solid shaft encoders with clamping flange; edge length 63.5mm; 3mm thick	
RFA-12	1544641	Aluminium flange adapter, rectangular, for solid shaft encoders with clamping flange; edge length 70mm; 10mm thick	
RFA-13	1544642	Aluminium flange adapter, rectangular, for solid shaft encoders with clamping flange; edge length 80mm; 4 mm thick	
RFA-1	1544630	Aluminium flange adapter, rectangular, for solid shaft encoders with clamping flange; edge length 58 mm; 4 mm thick	
RFA-4	1544633	Euro flange – aluminium flange adapter for solid shaft encoders, Ø 115 mm; reference diameter 100 mm; adapts 58 mm clamping flange to Euro flange	

**Rotative measurement  
Incremental rotary encoder  
Ri-10S6C-2B360-H1181**

**Accessories**

Type code	Ident no.	Description	Dimension drawing
RFA-6	1544635	Aluminium flange adapter for solid shaft encoders with clamping flange, Ø 58 mm; adapts clamping flange to synchro flange	
RFA-7	1544636	Aluminium flange adapter for solid shaft encoders, Ø 65 mm; adapts to Ø 65 mm flange and 48 mm reference diameter	
RFA-8	1544637	Aluminium flange adapter for solid shaft encoders with clamping flange, Ø 70 mm; thickness 4 mm, adapts to Ø 70 mm flange	
RFA-9	1544638	Aluminium angle flange for solid shaft encoders with Ø 58 mm clamping flange	
RFA-11	1544640	Aluminium flange adapter for solid shaft encoders with clamping flange, Ø 70 mm; thickness 10mm, adapts to Ø 70 mm flange	

**Rotative measurement  
Incremental rotary encoder  
Ri-10S6C-2B360-H1181**

**Accessories**

Type code	Ident no.	Description	Dimension drawing
RMW-1	1544643	Spring arm for encoders; max. contact pressure 40 N; for encoders with measuring wheel	
RMW-2	1544644	Aluminium measuring wheel (cross-knurled) for encoders, perimeter 0.2 m, width 12 mm, depth 10 mm	
RMW-3	1544645	Hytrel measuring wheel (smooth) for encoders, perimeter 0.2 m, width 12 mm, temp.range -10...+50°C, depth 10 mm	
RMW-4	1544646	Hytrel measuring wheel (grooved) for encoders, perimeter 0.2 m, width 12 mm, temp.range -10...+70 °C, depth 10 mm	
RMW-5	1544647	Aluminium measuring wheel (cross-knurled) for encoders, perimeter 0.5 m, width 25 mm, depth 10 mm	

**Rotative measurement  
Incremental rotary encoder  
Ri-10S6C-2B360-H1181**

**Accessories**

Type code	Ident no.	Description	Dimension drawing
RMW-6	1544648	Hytrel measuring wheel (smooth) for encoders, perimeter 0.5 m, width 25 mm, temp.range -10...+50°C, depth 10 mm	
RMW-7	1544649	Vulkollan measuring wheel (smooth) for encoders, perimeter 0.5 m, width 25 mm, temp.range -30...+80°C, depth 10 mm	
RMW-8	1544650	Aluminium measuring wheel with knobby rubber surface for encoders, perimeter 0.5 m, width 25 mm, temp.range -30...+80°C, depth 10 mm	
RMW-9	1544651	Hytrel measuring wheel (grooved) for encoders, perimeter 0.5 m, width 25 mm, temp.range -10...50 °C, depth 10 mm	