

**Rotative measurement
Incremental rotary encoder
Ri-12H15T-2B360-H1181**

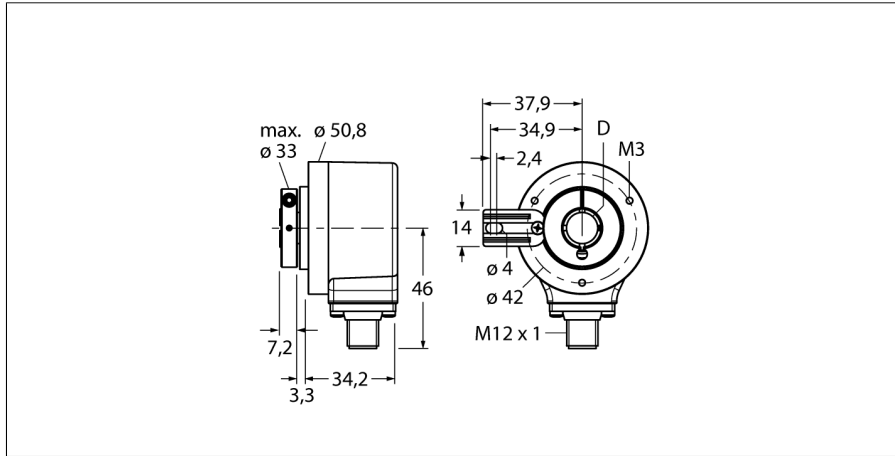

- Flange with torque stop, Ø 50.8 mm
- Hollow shaft, Ø 15mm
- Optical measuring principle
- Shaft material, stainless steel
- Protection class IP67 on the shaft side
- -40...+85°C
- Max. 6000 rev/min (continuous operation 3000 rev/min)
- 10...30 VDC
- Male connector, M12 x 1 , 8-pole
- Push-pull, with inversion
- Pulse frequency max. 300 kHz
- 360 pulses

Type code	Ri-12H15T-2B360-H1181
Ident no.	1545220

Measuring principle	Photoelectric
max. Drehzahl	6.000 U/min
Moment of inertia of the rotor	6 x10 ⁻⁶ kgm ²
Starting torque	0.05 Nm
Ambient temperature	-40...+85 °C

Operating voltage	10...30VDC
No-load current I ₀	≤ 100 mA
Output current	≤ 20 mA
Short-circuit protection	yes
Output function	8-wire, push-Pull, invertable
Output type	incremental
Resolution, incremental	360
Pulse frequency max.	300 kHz
Signal level high	min. U _s - 1 V
Signal level low	max. 0.5 V

Design	Hollow shaft
Flange type	Flange with torque stop
Flange diameter	50.8 mm
Shaft type	Hollow shaft
Shaft diameter D	15 mm
Shaft material	Stainless steel
Housing material	aluminium
Connection	male, M12 x 1 M12, 8-pole
Axial shaft load	40 N
Radial shaft load	80 N
Vibration resistance (EN 60068-2-6)	100 m/s ² , 10...2000 Hz
Shock resistance (EN 60068-2-27)	2500 m/s ² , 6 ms
Protection class housing	IP67
Protection class shaft	IP67

1	GND	
2	U _B	+
3	A	
4	A inv.	
5	B	
6	B inv.	
7	0	-
8	0 inv.	-
PH	shield	

**Rotative measurement
Incremental rotary encoder
Ri-12H15T-2B360-H1181****Pin configuration**

Signal	Gnd	+U _e	A	A inv.	B	B inv.	0	0 inv.	Shield
Pin configuration	1	2	3	4	5	6	7	8	PH

**Rotative measurement
Incremental rotary encoder
Ri-12H15T-2B360-H1181**

Accessories

Type code	Ident no.	Description	Dimension drawing
RME-4	1544615	Stainless steel mounting plate for hollow shaft encoders, reference diameter 80...170 mm, for low dynamic applications with axial and radial play	
RME-7	1544618	Stainless steel stator coupling for hollow shaft encoders, reference diameter 65mm, for highly dynamic applications with axial and radial play	
RME-8	1544619	Stainless steel mounting plate for hollow shaft encoders, reference diameter 65...91.5 mm, for applications with axial and radial play at constant rotation speed	
RME-9	1544620	Stainless steel mounting plate for hollow shaft encoders, reference diameter 64.5 mm, for low dynamic applications with axial and radial play	
RME-13	1544624	Plastic spring element for hollow shaft encoders, reference diameter 42 mm, for low dynamic applications with restricted axial play and limited mounting space.	

**Rotative measurement
Incremental rotary encoder
Ri-12H15T-2B360-H1181**

Accessories

Type code	Ident no.	Description	Dimension drawing
RME-14	1544625	Plastic spring element for hollow shaft encoders, reference diameters 44 mm, 60 mm, 63 mm, 65 mm, for low dynamic applications with high axial play.	