

**Pressure transmitter (front-flush)
with voltage output and PNP/NPN transistor switching output
PS010V-606-LUUPN8X-H1141**

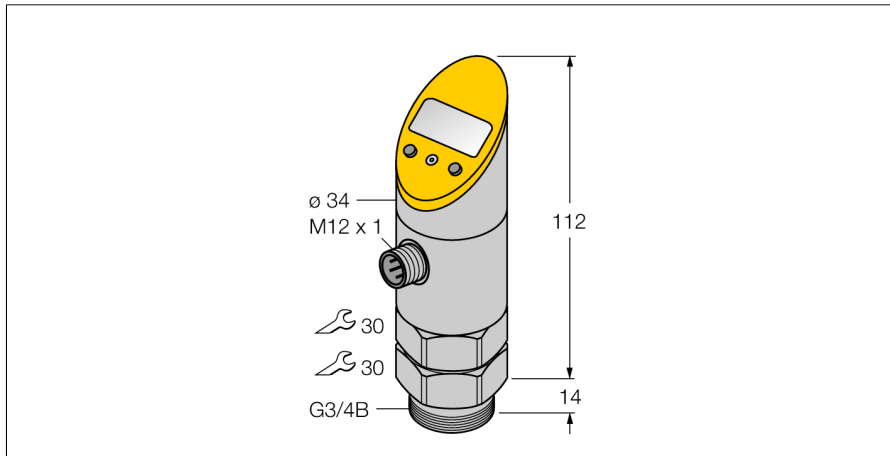

- Front-flush mounted diaphragm
- Reading of adjusted values without tools
- Secure programming through recessed pushbutton and keylock
- Permanent indication of pressure (bar, psi, kPa, MPa...)
- Peak pressure memory
- Pressure range -1 ... 10 bar rel.

Wiring diagram



Functional principle

The pressure sensors of the PS series operate with piezo-resistive ceramic measuring cells. The ceramic diaphragm is unbalanced in proportion to the pressure applied. Depending on the sensor type, the voltage produced is made available either as switching or analog output signal. Non-rotatable and rotatable sensors, numerous thread types, front-flush or dead-zone free diaphragms and an accuracy of 0.5% of full scale guarantee highest flexibility and safe process interfacing.

Type code	PS010V-606-LUUPN8X-H1141
Ident no.	6833029
Relative pressure	-1...10bar rel.
Operating range	-14.5...145.04psi
Operating range	-0.1...1MPa
Admissible overpressure	≤ 25 bar
Burst pressure	≥ 25 bar
Power supply	
Operating voltage	18...30VDC
No-load current I ₀	≤ 50 mA
Voltage drop at I ₀	≤ 2 V
Protective measure	SELV; PELV according to EN 50178
Short-circuit/reverse polarity protection	yes/ yes
Protection type and class	IP67/ III
Outputs	
Output 1	Switching output or IO-Link mode
Output 2	analogue output
Switching output	
Output function	NO/NC , PNP/NPN
Accuracy switching output	± 0.5 % v. E. BSL
Rated operational current	0.2 A
Switching frequency	≤ 180 Hz
Switching point distance	≥ 0.5 %
Switch point:	(min + 0.005 x range) up to 100% f.s.
Release point(s)	min up to (SP - 0.005 x range)
Switching cycles	≥ 100 mil.
Analogue output	
Voltage output	≥0...≤10V
Operating range	0...10 V, 0...5 V (3-wire)
Load	≥ 2 kΩ
Accuracy LHR analog output	± 0.5 % of final value BSL
Response time	< 3 ms
IO-Link	
Communication	specified acc. to version 1.0
Parameterization	FDT / DTM
Transmission physics	corresponds to 3-wire physics (PHY2)
Transmission rate	COM 2 / 38.4 kbps
Process data width	16 bit
Measured value information	14 bit
Switchpoint information	2 bit
Frame type	2.2
Genauigkeit	± 0.5 % of final value BSL

**Pressure transmitter (front-flush)
with voltage output and PNP/NPN transistor switching output
PS010V-606-LUUPN8X-H1141**

Temperature behaviour

Medium temperature	-10...85 °C
Temperature coefficient zero point T_{s0}	$\pm 0.15\%$ of full scale / 10 K
Temperature coefficient span $T_{s\Delta}$	$\pm 0.15\%$ of full scale / 10 K

Ambient conditions

Ambient temperature	-40...80 °C
Storage temperature	-40...+80 °C
Vibration resistance	20 g (9...2000 Hz), according to IEC 68-2-6
Shock resistance	50 g (11 ms), according to IEC 61508
EMC	EN 61000-4-2 ESD:4 kV CD / 8 kV AD EN 61000-4-3 HF gestraht:15 V/m EN 61000-4-4 Burst:2 kV EN 61000-4-5 Surge: 500 V, 12 Ohm EN 61000-4-6 HF conducted:10 V

Housing

Housing material	stainless-steel/plastic, V2A (1.4305)
material pressure connection	stainless steel A4 1.4435 (AISI 316L)
Process connection	G 3/4" front-flush
Wrench size pressure connection / coupling nut	30/ 30
Connection	male, M12 x 1

Reference conditions acc. to IEC 61298-1

temperature	15...25 °C
Atmospheric pressure	860...1060 hPa abs.
Humidity	45...75 % rel.
Auxiliary power	24 VDC

Display

	4-digit 7-segment display, rotatable by 180°, disengageable
Switching state	LED yellow
Programming options	start/end value analog output; switch/release point; PNP/NPN; NO/NC contact; hysteresis/window mode; damping; pressure unit; peak pressure memory
Unit display	5 x LEDs green (bar, psi, kPa, MPa, misc)

**Pressure transmitter (front-flush)
with voltage output and PNP/NPN transistor switching output
PS010V-606-LUUPN8X-H1141**

Accessories

Type code	Ident no.	Description	Dimension drawing
PTS-Cover	6907410	Protective cap	

Wiring accessories

Type code	Ident no.	Description	Dimension drawing
RKC4.4T-2/TEL	6625013	Connection cable, female M12, straight, 4-pin, cable length: 2 m, sheath material: PVC, black; cULus approval; other cable lengths and qualities available, see www.turck.com	
WKC4.4T-2/TEL	6625025	Connection cable, female M12, angled, 4-pin, cable length: 2 m, sheath material: PVC, black; cULus approval; other cable lengths and qualities available, see www.turck.com	
RKC4.4T-2/TXL	6625503	Connection cable, female M12, straight, 4-pin, cable length: 2 m, sheath material: PUR, black; cULus approval; other cable lengths and qualities available, see www.turck.com	
WKC4.4T-2/TXL	6625515	Connection cable, female M12, angled, 4-pin, cable length: 2 m, sheath material: PUR, black; cULus approval; other cable lengths and qualities available, see www.turck.com	