

**Pressure transmitter
with voltage output (3-wire)
PT001R-11-LU2-H1131**

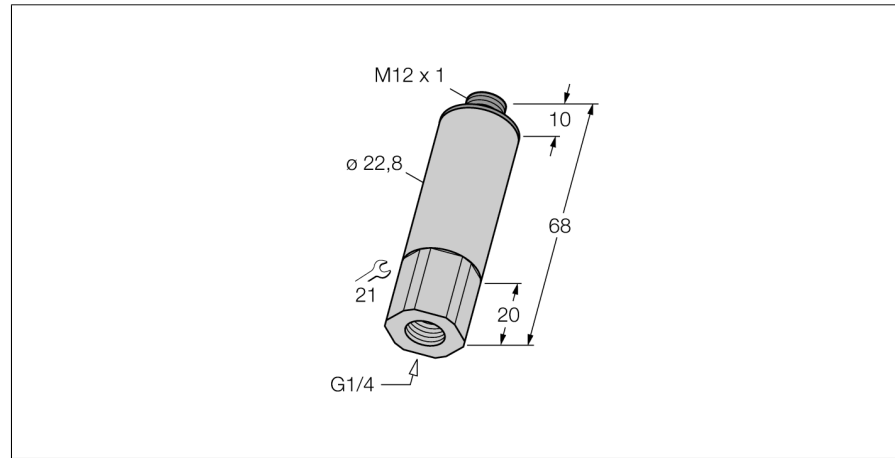

- Compact and robust design
- Pressure connection with integrated peak pressure aperture
- Minimum influence of temperature on accuracy within the entire temperature range of -40...+125°C
- Excellent EMC properties
- Pressure range 0 ... 1 bar rel.

Wiring diagram

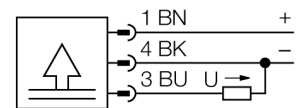

Functional principle

The pressure transmitters of the PT...-1 series operate with piezo-resistive ceramic measuring cells. The ceramic diaphragm is unbalanced in proportion to the pressure applied. Depending on the sensor type used, the processed signal is provided as an analog output signal 4...20mA (2-wire) or 0...10V (3-wire).

Type code	PT001R-11-LU2-H1131
Ident no.	6831483
Relative pressure	0...1bar rel.
Operating range	0...14.5psi
Operating range	0...0.1MPa
Admissible overpressure	≤ 3 bar
Burst pressure	≥ 3 bar
Power supply	
Operating voltage	11.4...33VDC
Protective measure	SELV according to EN 50178
Short-circuit/reverse polarity protection	yes/ yes
Protection type and class	IP67/ III
MTTF	760 years acc. to SN 29500 (Ed. 99) 40 °C
Outputs	
Output 1	analog output
Analogue output	
Voltage output	≥0...≤10V
Operating range	0...10 V (3-wire)
Load	≥ 10 kΩ
Accuracy LHR analog output	± 0.3 % of final value BSL
Calibration accuracy 0-point	0.3 % of final value
Calibration accuracy, of final value	0.3 % of final value
Response time	< 3 ms
Temperature behaviour	
Medium temperature	-40...125 °C
Temperature coefficient zero point T ₀	± 0.15 % of full scale / 10 K
Temperature coefficient span T _s	± 0.15 % of full scale / 10 K
Ambient conditions	
Ambient temperature	-40...85 °C
Storage temperature	-40...+85°C
Vibration resistance	20 x g (9...2000 Hz, 2...9 Hz with an amplitude +/-15 mm), acc. to IEC 68-2-6
Shock resistance	100 g (11 ms) , according to IEC 61508
Housing	
Housing material	stainless-steel/plastic, V2A (1.4305)
material pressure connection	stainless steel A2 1.4305 (AISI 303)
material pressure element	ceramics Al ₂ O ₃
Sealing material	FPM
Process connection	G 1/4" female thread
Wrench size pressure connection / coupling nut	SW21
Connection	male, M12 x 1

**Pressure transmitter
with voltage output (3-wire)
PT001R-11-LU2-H1131**

Reference conditions acc. to IEC 61298-1

temperature	15...25 °C
Atmospheric pressure	860...1060 hPa abs.
Humidity	45...75 % rel.
Auxiliary power	24 VDC

**Pressure transmitter
with voltage output (3-wire)
PT001R-11-LU2-H1131**

Wiring accessories

Type code	Ident no.	Description	Dimension drawing
RKC4.4T-2/TEL	6625013	Connection cable, female M12, straight, 4-pin, cable length: 2 m, sheath material: PVC, black; cULus approval; other cable lengths and qualities available, see www.turck.com	
WKC4.4T-2/TEL	6625025	Connection cable, female M12, angled, 4-pin, cable length: 2 m, sheath material: PVC, black; cULus approval; other cable lengths and qualities available, see www.turck.com	
RKC4.4T-2/TXL	6625503	Connection cable, female M12, straight, 4-pin, cable length: 2 m, sheath material: PUR, black; cULus approval; other cable lengths and qualities available, see www.turck.com	
WKC4.4T-2/TXL	6625515	Connection cable, female M12, angled, 4-pin, cable length: 2 m, sheath material: PUR, black; cULus approval; other cable lengths and qualities available, see www.turck.com	