

Pressure switch
2 PNP/NPN transistor switching outputs
PC400R-203-2UPN8X-H1141

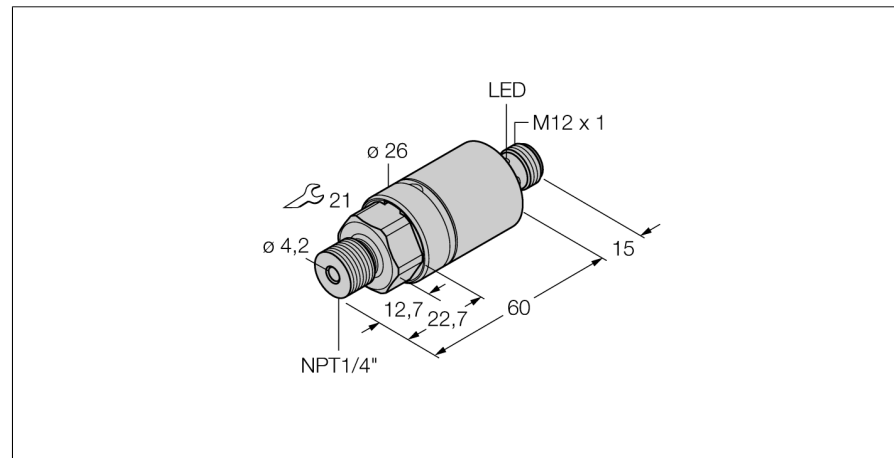

- Cylindrical version without display
- 2 PNP/NPN switching outputs
- Communication via IO-Link
- Display of switching state and communication via LED at M12 connector
- Pressure range 0 ... 400 bar rel.

Wiring diagram



Functional principle

The IO-Link pressure transmitters of the PC 200 series operate with piezoresistive ceramic measuring cells. The ceramic diaphragm is unbalanced in proportion to the pressure applied. The digitally processed signal is made available via IO-Link or as switching output. Highest flexibility and 0.5 % f.s. accuracy guarantee secure connection to your processes.

Type code	PC400R-203-2UPN8X-H1141
Ident no.	6833747
Relative pressure	0...400bar rel.
Operating range	0...5802psi
Operating range	0...40MPa
Switch point SP1	customized
Release point rP1	customized
Admissible overpressure	≤ 800 bar
Burst pressure	≥ 800 bar
Power supply	
Operating voltage	15...30VDC
No-load current I ₀	≤ 12 mA
Voltage drop at I ₀	≤ 2 V
Protective measure	SELV; PELV according to EN 50178
Short-circuit/reverse polarity protection	yes/ yes
Protection type and class	IP69K/ III
Output 1	Switching output or IO-Link mode
Output 2	switching output
Switching output	
Output function	NO/NC , PNP/NPN
Accuracy switching output	± 0.5 % v. E. BSL
Rated operational current	0.15 A
Switching frequency	≤ 180 Hz
Switching point distance	≥ 0.5 %
Switch point:	(min + 0.005 x range) up to 100% f.s.
Release point(s)	min up to (SP - 0.005 x range)
Switching cycles	≥ 100 mil.
Switch point SP1	customized
Release point rP1	customized
Response time	< 3 ms
IO-Link	
Communication	specified acc. to version 1.0
Parameterization	FDT / DTM
Transmission physics	corresponds to 3-wire physics (PHY2)
Transmission rate	COM 2 / 38.4 kbps
Process data width	16 bit
Measured value information	14 bit
Switchpoint information	2 bit
Frame type	2.2
Genauigkeit	± 0.5 % of final value BSL

Pressure switch
2 PNP/NPN transistor switching outputs
PC400R-203-2UPN8X-H1141

Temperature behaviour

Medium temperature	-40...85 °C
Temperature coefficient zero point T_{k0}	± 0.15 % of full scale / 10 K
Temperature coefficient span $T_{k\Delta}$	± 0.15 % of full scale / 10 K

Ambient conditions

Ambient temperature	-40...80 °C
Storage temperature	-40...+80 °C
Vibration resistance	20 g (9...2000 Hz), according to IEC 68-2-6
Shock resistance	50 , according to IEC 61508

Housing

Housing material	stainless steel, 1.4305 (AISI 303)/PBT-GF15
material pressure connection	stainless steel A2 1.4305 (AISI 303)
material pressure element	ceramics AL2O3
Sealing material	FPM
Process connection	NPT 1/4" - 18 male thread
Wrench size pressure connection / coupling nut	21
Connection	male, M12 x 1

Reference conditions acc. to IEC 61298-1

temperature	15...25 °C
Atmospheric pressure	860...1060 hPa abs.
Humidity	45...75 % rel.
Auxiliary power	24 VDC

Switching state

Programming options	LED switch/release point, PNP/NPN, NO/NC, hysteresis/window mode, muting, pressure unit, peak pressure memory
---------------------	--

Pressure switch
2 PNP/NPN transistor switching outputs
PC400R-203-2UPN8X-H1141

Wiring accessories

Type code	Ident no.	Description	Dimension drawing
RKC4.4T-2/TEL	6625013	Connection cable, female M12, straight, 4-pin, cable length: 2 m, sheath material: PVC, black; cULus approval; other cable lengths and qualities available, see www.turck.com	
WKC4.4T-2/TEL	6625025	Connection cable, female M12, angled, 4-pin, cable length: 2 m, sheath material: PVC, black; cULus approval; other cable lengths and qualities available, see www.turck.com	
RKC4.4T-2/TXL	6625503	Connection cable, female M12, straight, 4-pin, cable length: 2 m, sheath material: PUR, black; cULus approval; other cable lengths and qualities available, see www.turck.com	
WKC4.4T-2/TXL	6625515	Connection cable, female M12, angled, 4-pin, cable length: 2 m, sheath material: PUR, black; cULus approval; other cable lengths and qualities available, see www.turck.com	