

**Temperature measurement  
miniature transmitter with integrated probe  
TTM050C-203A-CF-LI6-H1140-L150 -50...50°C**

- Miniature design
- Analog output 4...20 mA
- Temperature range -50...+50 °C

**Wiring diagram**

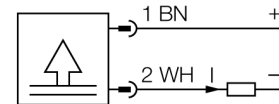

**General description**

Temperatures are recorded over a mineral insulated transmitter and converted into a wide range of electrical output signals.

The devices of the TTM miniature series are enclosed in a fully potted plastic housing and depending on the variant, they have either an IO-link output, power output and/or switching output.

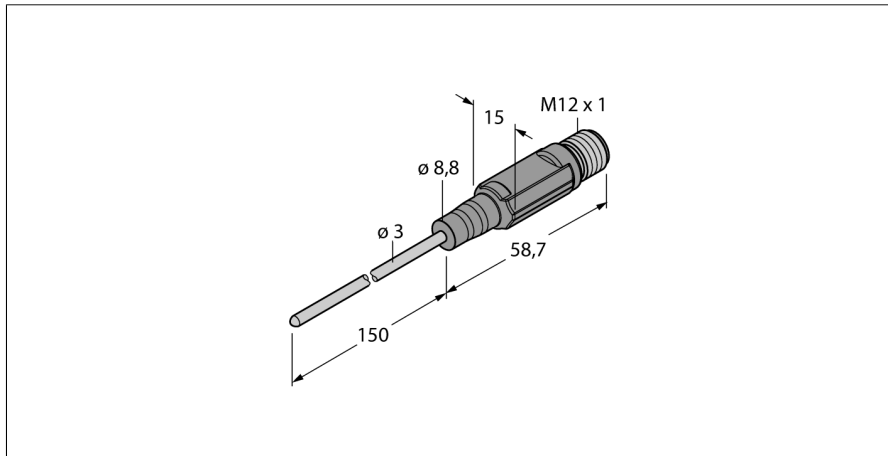

<b>Type code</b>	TTM050C-203A-CF-LI6-H1140-L150 -50...50°C
Ident no.	9910540
<b>Temperature range</b>	-50...50 °C
Temperature operating range	-58...122°F
Measuring element	Pt-100 platinum measuring element, DIN EN 60751
Accuracy	Class A
Response time	t0.5 = 1.5 s/ t0.9 = 6.0 s in water at 0.2 m/s
Immersion depth (L)	150 mm
<b>Power supply</b>	
Operating voltage	10...24VDC
No-load current I <sub>0</sub>	≤ 20 mA
Short-circuit/reverse polarity protection	yes/ yes
Protection type and class	IP67/ III
<b>Outputs</b>	
Output 1	analog output
<b>Analogue output</b>	
Operating range	4...20 mA (2-wire)
Load	≤ 700 kΩ
Accuracy (Lin. + Hys. + Rep.)	± 0.2 K
<b>Temperature behaviour</b>	
Temperature coefficient zero point T <sub>0</sub>	± 0.1 % of full scale / 10 K
Temperature coefficient span T <sub>Δ</sub>	± 0.1 % of full scale / 10 K
<b>Ambient conditions</b>	
Ambient temperature	-40...80 °C
Storage temperature	-40...+80°C
Pressure resistance	100 bar
<b>Housing</b>	
Housing material	stainless-steel/plastic, V4A (1.4404)
Sensor material	stainless steel, AISI 316L
Process connection	for compression fittings, thermowells or direct mounting
Connection	male, M12 x 1
Pressure resistance	100 bar
<b>Reference conditions acc. to IEC 61298-1</b>	
temperature	15...25 °C
Atmospheric pressure	860...1060 hPa abs.
Humidity	45...75 % rel.
Auxiliary power	24 VDC

**Temperature measurement  
miniature transmitter with integrated probe  
TTM050C-203A-CF-LI6-H1140-L150 -50...50°C**

**Wiring accessories**

Type code	Ident no.	Description	Dimension drawing
RKC4.4T-2/TEL	6625013	Connection cable, female M12, straight, 4-pin, cable length: 2 m, sheath material: PVC, black; cULus approval; other cable lengths and qualities available, see <a href="http://www.turck.com">www.turck.com</a>	
WKC4.4T-2/TEL	6625025	Connection cable, female M12, angled, 4-pin, cable length: 2 m, sheath material: PVC, black; cULus approval; other cable lengths and qualities available, see <a href="http://www.turck.com">www.turck.com</a>	
RKC4.4T-2/TXL	6625503	Connection cable, female M12, straight, 4-pin, cable length: 2 m, sheath material: PUR, black; cULus approval; other cable lengths and qualities available, see <a href="http://www.turck.com">www.turck.com</a>	
WKC4.4T-2/TXL	6625515	Connection cable, female M12, angled, 4-pin, cable length: 2 m, sheath material: PUR, black; cULus approval; other cable lengths and qualities available, see <a href="http://www.turck.com">www.turck.com</a>	