

**Temperature measurement
Probe
TP-306A-CF-H1141-L5000**

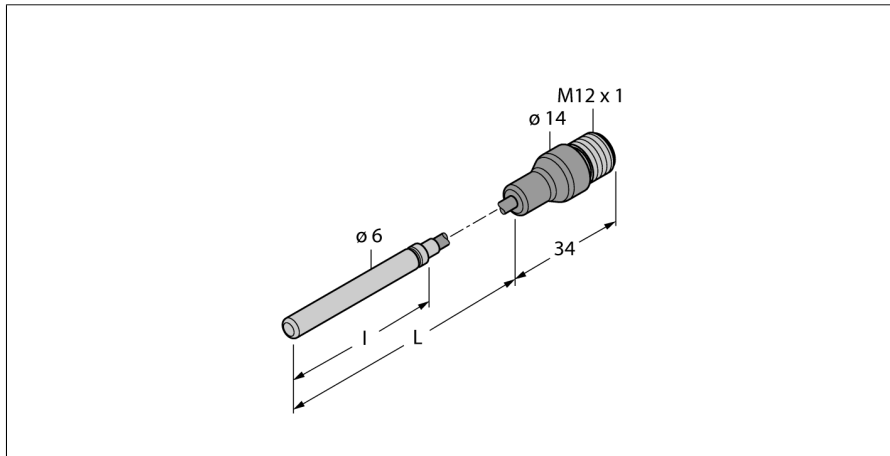

- Pt-100 probe acc. to DIN EN 60751
- Vibration and shock-resistant
- Connectable to TS, TTM, IM34, BL20, BL67
- Temperature range -50...+105 °C
- 4-wire connection technology

Wiring diagram

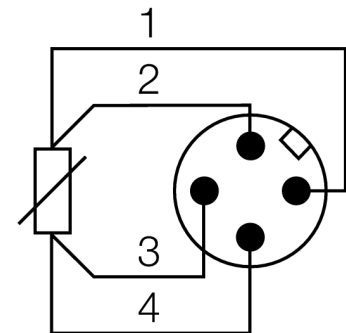

Type code	TP-306A-CF-H1141-L5000
Ident no.	9910481
Temperature range	-50...105 °C
Temperature operating range	-58...221 °F
Measuring element	Pt-100 platinum measuring element, DIN EN 60751
Accuracy	Class A
Response time	t _{0.5} = 8 s / t _{0.9} = 20 s in water at 0.2 m/s
Immersion depth (L)	5000 mm
Protection type and class	IP67
MTTF	2283 years acc. to SN 29500 (Ed. 99) 40 °C
Housing	
Housing material	stainless-steel/plastic, V4A (1.4404)
Sensor material	stainless steel, AISI 316L
Process connection	for compression fittings, thermowells or direct mounting
Connection	male, M12 x 1
Reference conditions acc. to IEC 61298-1	
temperature	15...25 °C
Atmospheric pressure	860...1060 hPa abs.
Humidity	45...75 % rel.
Auxiliary power	24 VDC

**Temperature measurement
Probe
TP-306A-CF-H1141-L5000**

Wiring accessories

Type code	Ident no.	Description	Dimension drawing
RKC4.4T-2/TEL	6625013	Connection cable, female M12, straight, 4-pin, cable length: 2 m, sheath material: PVC, black; cULus approval; other cable lengths and qualities available, see www.turck.com	
WKC4.4T-2/TEL	6625025	Connection cable, female M12, angled, 4-pin, cable length: 2 m, sheath material: PVC, black; cULus approval; other cable lengths and qualities available, see www.turck.com	
RKC4.4T-2/TXL	6625503	Connection cable, female M12, straight, 4-pin, cable length: 2 m, sheath material: PUR, black; cULus approval; other cable lengths and qualities available, see www.turck.com	
WKC4.4T-2/TXL	6625515	Connection cable, female M12, angled, 4-pin, cable length: 2 m, sheath material: PUR, black; cULus approval; other cable lengths and qualities available, see www.turck.com	