

**Temperature measurement
Accessories thermowell
THW-3-N1/8-A4-L050**

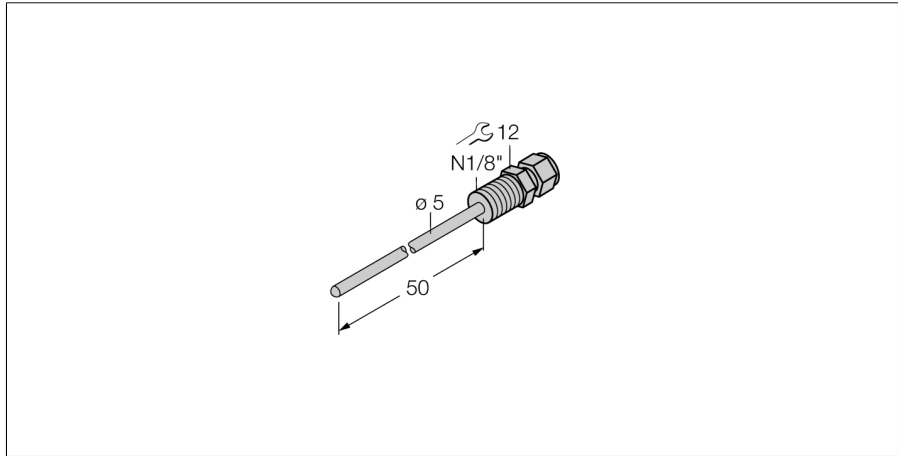

- Thermowell for mounting TS203 probes
- Process connection 1/8" NPT male thread

General description

Thermowells are used for unpressurized mounting of probes. They protect the probes against direct contact with the medium. The probe can be replaced without interrupting the process.

Type code	THW-3-N1/8-A4-L050
Ident no.	9910414
Temperature range	-50...350 °C
Temperature operating range	-58...662 °F
Immersion depth (L)	50 mm
Pressure resistance	400 bar
Housing	
Housing material	stainless steel 1.4404 (AISI 316L), V4A (1.4404)
Sealing material	stainless steel
Process connection	NPT 1/8" male thread
Pressure resistance	400 bar
Max. tightening torque housing nut	100 Nm