

**Temperature measurement  
Accessories thermowell  
THW-3-DN25K-A4-L150**

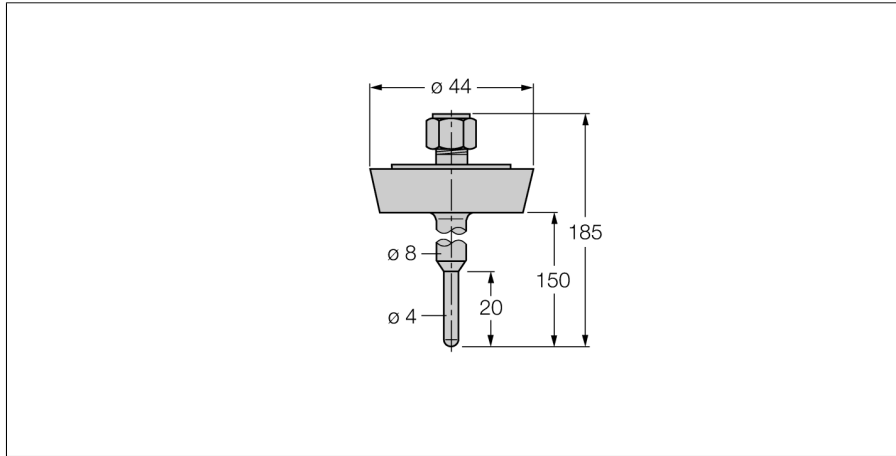

- Thermowell for mounting TS203 probes
- For use in food and pharmaceutical applications
- Surface roughness Ra > 0.8 µm

**General description**

Thermowells are used for unpressurized mounting of probes. They protect the probes against direct contact with the medium. The probe can be replaced without interrupting the process.

<b>Type code</b>	THW-3-DN25K-A4-L150
Ident no.	9910457
<b>Temperature range</b>	-50...350 °C
Temperature operating range	-58...662°F
Immersion depth (L)	150 mm
<b>Pressure resistance</b>	40 bar
<b>Housing</b>	
Housing material	stainless steel 1.4404 (AISI 316L), V4A (1.4404)
Sealing material	stainless steel
Process connection	Threaded tube connection per DIN11851
Pressure resistance	40 bar
Max. tightening torque housing nut	100 Nm