

**Temperature measurement  
Accessories thermowell  
THW-6-DN25K-A4-L050**

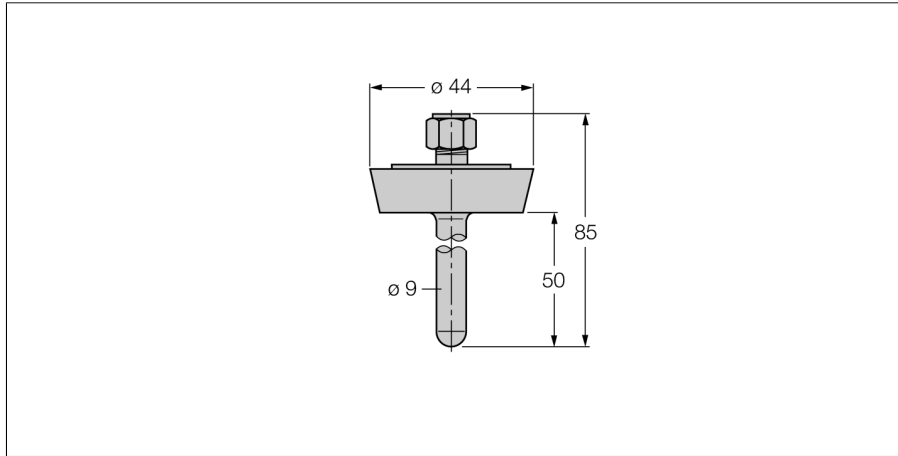

- Thermowell for temperature probes (6 mm diameter, TP series)
- For use in food and pharmaceutical applications
- Surface roughness Ra > 0.8 µm

**General description**

Thermowells protect the probes against aggressive substances and high pressures. The probes do not come into contact with any media. They can be replaced without interrupting the process.

<b>Type code</b>	THW-6-DN25K-A4-L050
Ident no.	9910471
<b>Temperature range</b>	-50...350 °C
Temperature operating range	-58...662°F
Immersion depth (L)	50 mm
<b>Pressure resistance</b>	40 bar
<b>Housing</b>	
Housing material	stainless steel 1.4404 (AISI 316L), V4A (1.4404)
Sealing material	stainless steel
Process connection	Threaded tube connection per DIN11851
Pressure resistance	40 bar
Max. tightening torque housing nut	100 Nm