

**Temperature measurement
Accessories thermowell
THW-6-TRI3/4-A4-L250**

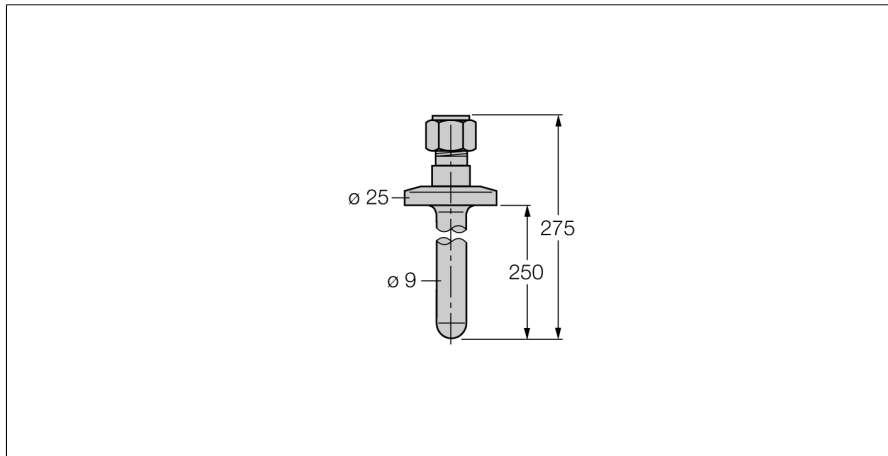

- Thermowell for temperature probes (6 mm diameter, TP series)
- For use in food and pharmaceutical applications
- Surface roughness Ra > 0.8 µm

General description

Thermowells protect the probes against aggressive substances and high pressures. The probes do not come into contact with any media. They can be replaced without interrupting the process.

Type code	THW-6-TRI3/4-A4-L250
Ident no.	9910470
Temperature range	-50...350 °C
Temperature operating range	-58...662 °F
Immersion depth (L)	250 mm
Pressure resistance	40 bar
Housing	
Housing material	stainless steel 1.4404 (AISI 316L), V4A (1.4404)
Sealing material	stainless steel
Process connection	Tri-Clamp 3/4"
Pressure resistance	40 bar
Max. tightening torque housing nut	100 Nm