

**Temperature measurement  
with voltage output and PNP/NPN transistor switching output  
TS-400-LUUPN8X-H1141**

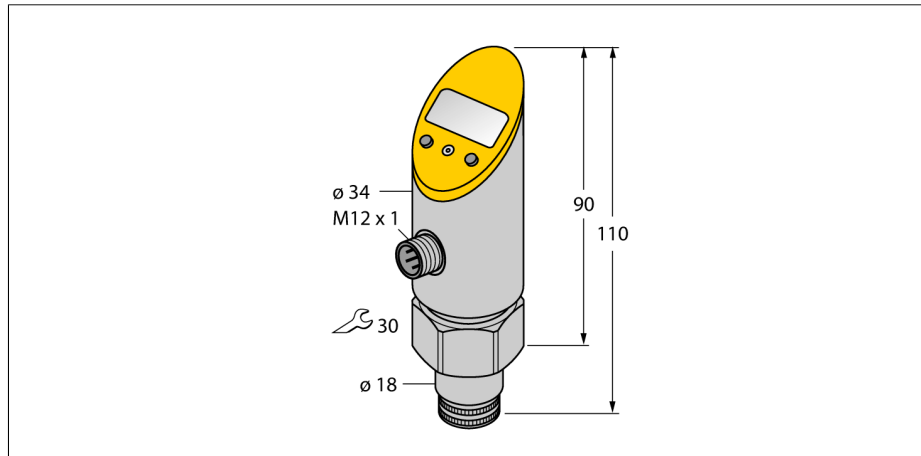

- Reading of adjusted values without tools
- Secure programming through recessed pushbutton and keylock
- Permanent display of temperature unit (°C, °F, K, Ohm)
- Temperature peak memory
- Temperature range -50...500 °C

**Wiring diagram**

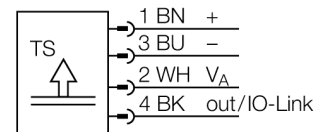

**General description**

The TS series is a compact processing and display unit with a 4-digit 7-segment display. Available are versions with non-rotatable (TS400) or rotatable (TS500) body and various output types.

<b>Type</b>	TS-400-LUUPN8X-H1141
Ident-No.	6840008
<b>Temperature operating range</b>	-50...500 °C
<b>Power supply</b>	
Operating voltage	18...30VDC
No-load current I <sub>0</sub>	≤ 50 mA
Voltage drop at I <sub>0</sub>	≤ 2 V
Protective measure	SELV; PELV according to EN 50178
Short-circuit/reverse polarity protection	yes/ yes
Protection type and class	IP67/ III
<b>Outputs</b>	
Output 1	Switching output or IO-Link mode
Output 2	analogue output
<b>Switching output</b>	
Output function	NO/NC programmable, PNP/NPN
Switching point accuracy	± 0.2 K
Repeatability	± 0.1 % of full scale
Rated operational current	0.2 A
Switching frequency	≤ 180 Hz
Switching point distance	≥ 0.2 K
Switching cycles	≥ 100 mil.
Release points	-50...499.8°C
Switching point	-49.8...500°C
<b>Analogue output</b>	
Voltage output	≥0...≤10V
Operating range	0...10 V/0...5 V/1...6 V (3-wire)
Load	≥ 2 kΩ
Accuracy (Lin. + Hys. + Rep.)	± 0.2 K
Anmerkung	0.1% of full scale applies to temperatures > 200°C
Repeatability	0.1 K
Response time	< 100 ms
<b>IO-Link</b>	
Communication	specified acc. to version 1.0
Parameterization	FDT/DTM
Transmission physics	corresponds to 3-wire physics (PHY2)
Transmission rate	COM 2 / 38.4 kbps
Process data width	16 bit
Measured value information	14 bit
Switchpoint information	2 bit
Frame type	2.2
Genauigkeit	± 0.2 K

# Temperature measurement with voltage output and PNP/NPN transistor switching output TS-400-LUUPN8X-H1141

---

## Temperature behaviour

Temperature coefficient zero point $T_{k0}$	$\pm 0.15\%$ of full scale / 10 K
Temperature coefficient span $T_{kS}$	$\pm 0.15\%$ of full scale / 10 K

---

## Ambient conditions

Ambient temperature	-40...80 °C
Storage temperature	-40...+80°C
Vibration resistance	20 g (9...2000 Hz), according to IEC 68-2-6
Shock resistance	50 g (11 ms) , according to IEC 61508
EMC	EN 61000-4-2 ESD:4 kV CD / 8 kV AD EN 61000-4-3 HF radiated:15 V/m EN 61000-4-4 Burst:2 kV EN 61000-4-5 Surge: 1 kV, 42 Ohm EN 61000-4-6 HF conducted:10 V

---

## Housing

Housing material	Stainless-steel/plastic, V2A (1.4305)
Mechanical connection	Cylindrical, Ø 18mm
Connection	male, M12 x 1

---

## Reference conditions acc. to IEC 61298-1

temperature	15...25 °C
Atmospheric pressure	860...1060 hPa abs.
Humidity	45...75 % rel.
Auxiliary power	24 VDC

---

## Display

Display	4-digit 7-segment, rotatable by 180°
Switching state	2 x LEDs yellow
Programming options	Switch/release point, hysteresis/window mode, NO/NC; unit
Unit display	4 x green LED (°C, °F, K, Ohm)

**Temperature measurement  
with voltage output and PNP/NPN transistor switching output  
TS-400-LUUPN8X-H1141**

**Accessories**

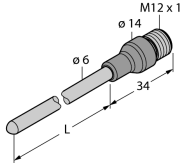
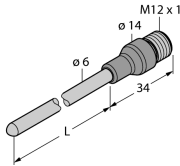
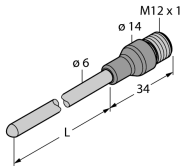
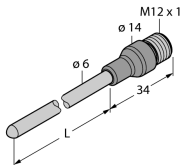
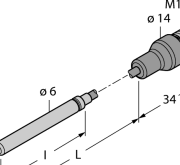
Type code	Ident-No.		Dimension drawing
TP-206A-CF-H1141-L200	9910477	temperature detector for liquid and gaseous media	
TP-206A-CF-H1141-L100	9910475	temperature detector for liquid and gaseous media	
TP-206A-CF-H1141-L150	9910476	temperature detector for liquid and gaseous media	
TP-206A-CF-H1141-L300	9910478	temperature detector for liquid and gaseous media	
TP-306A-CF-H1141-L1000	9910479	temperature detector for liquid and gaseous media	

**Temperature measurement  
with voltage output and PNP/NPN transistor switching output  
TS-400-LUUPN8X-H1141**

**Accessories**

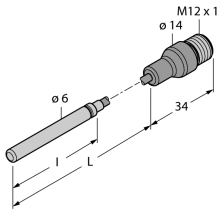
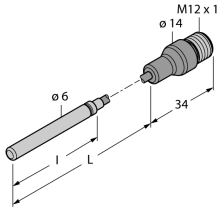
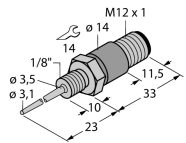
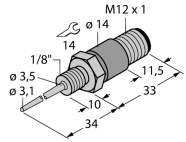
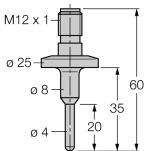
Type code	Ident-No.		Dimension drawing
TP-306A-CF-H1141-L2000	9910480	temperature detector for liquid and gaseous media	
TP-306A-CF-H1141-L5000	9910481	temperature detector for liquid and gaseous media	
TP-103A-G1/8-H1141-L013	9910400	temperature detector for liquid and gaseous media	
TP-103A-G1/8-H1141-L024	9910401	temperature detector for liquid and gaseous media	
TP-104A-TRI3/4-H1141-L035	9910429	temperature detector for liquid and gaseous media	

**Temperature measurement  
with voltage output and PNP/NPN transistor switching output  
TS-400-LUUPN8X-H1141**

**Accessories**

Type code	Ident-No.		Dimension drawing
TP-104A-TRI3/4-H1141-L100	9910430	temperature detector for liquid and gaseous media	
TP-104A-DN25K-H1141-L035	9910431	temperature detector for liquid and gaseous media	
TP-104A-DN25K-H1141-L100	9910432	temperature detector for liquid and gaseous media	
BSS-18	6901320	Mounting bracket for smooth and threaded barrel devices; material: Polypropylene	