

**Temperature measurement
Probe
TP-203A-CF-H1141-L150**

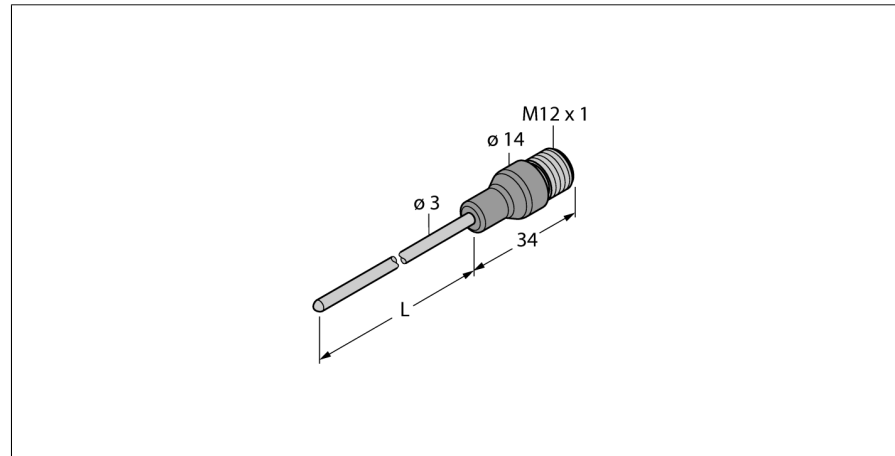

- Pt-100 probe acc. to DIN EN 60751
- Vibration and shock-resistant
- Connectable to TS, TTM, IM34, BL20, BL67
- Temperature range -50...+500 °C
- 4-wire connection technology

Wiring diagram

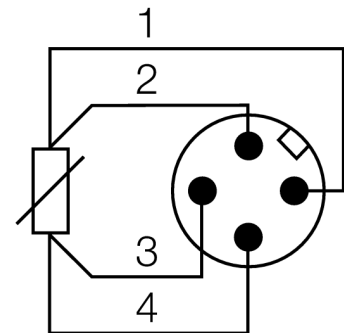



Type code	TP-203A-CF-H1141-L150
Ident no.	9910403
Temperature range	-50...500 °C
Temperature operating range	-58...932°F
Measuring element	Pt-100 platinum measuring element, DIN EN 60751
Accuracy	Class A
Response time	t0.5 = 1.5 s / t0.9 = 6.0 s in water at 0.2 m/s
Immersion depth (L)	150 mm
Protection type and class	IP67
MTTF	2283 years acc. to SN 29500 (Ed. 99) 40 °C
Ambient conditions	
Ambient temperature	-40...+120 °C
Storage temperature	-40...+85°C
Pressure resistance	100 bar
Housing	
Housing material	stainless-steel/plastic, V4A (1.4404)
Sensor material	stainless steel, AISI 316L
Process connection	for compression fittings, thermowells or direct mounting
Connection	male, M12 x 1
Pressure resistance	100 bar
Reference conditions acc. to IEC 61298-1	
temperature	15...25 °C
Atmospheric pressure	860...1060 hPa abs.
Humidity	45...75 % rel.
Auxiliary power	24 VDC

**Temperature measurement
Probe
TP-203A-CF-H1141-L150**

TURCK

Industrial
Automation

Accessories

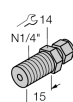
Type code	Ident no.	Description	Dimension drawing
CF-M-3-G1/8-A4	9910405	Compression ferrule fittings for direct mounting of temperature probes	
CF-M-3-N1/8-A4	9910406	Compression ferrule fittings for direct mounting of temperature probes	
CF-M-3-G1/4-A4	9910407	Compression ferrule fittings for direct mounting of temperature probes	
CF-M-3-N1/4-A4	9910408	Compression ferrule fittings for direct mounting of temperature probes	

Wiring accessories

Type code	Ident no.	Description	Dimension drawing
RKC4.4T-2/TEL	6625013	Connection cable, female M12, straight, 4-pin, cable length: 2 m, sheath material: PVC, black; cULus approval; other cable lengths and qualities available, see www.turck.com	

**Temperature measurement
Probe
TP-203A-CF-H1141-L150**

Wiring accessories

Type code	Ident no.	Description	Dimension drawing
WKC4.4T-2/TEL	6625025	Connection cable, female M12, angled, 4-pin, cable length: 2 m, sheath material: PVC, black; cULus approval; other cable lengths and qualities available, see www.turck.com	
RKC4.4T-2/TXL	6625503	Connection cable, female M12, straight, 4-pin, cable length: 2 m, sheath material: PUR, black; cULus approval; other cable lengths and qualities available, see www.turck.com	
WKC4.4T-2/TXL	6625515	Connection cable, female M12, angled, 4-pin, cable length: 2 m, sheath material: PUR, black; cULus approval; other cable lengths and qualities available, see www.turck.com	