

**Temperature measurement
miniature transmitter with integrated probe
TTM150C-206A-CF-LI6-H1140-L200**

- Miniature design
- Analog output 4...20 mA
- Temperature range 0...+150 °C

Wiring diagram

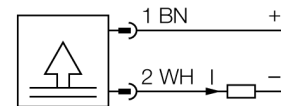

General description

Temperatures are recorded over a mineral insulated transmitter and converted into a wide range of electrical output signals.

The devices of the TTM miniature series are enclosed in a fully potted plastic housing and depending on the variant, they have either an IO-link output, power output and/or switching output.

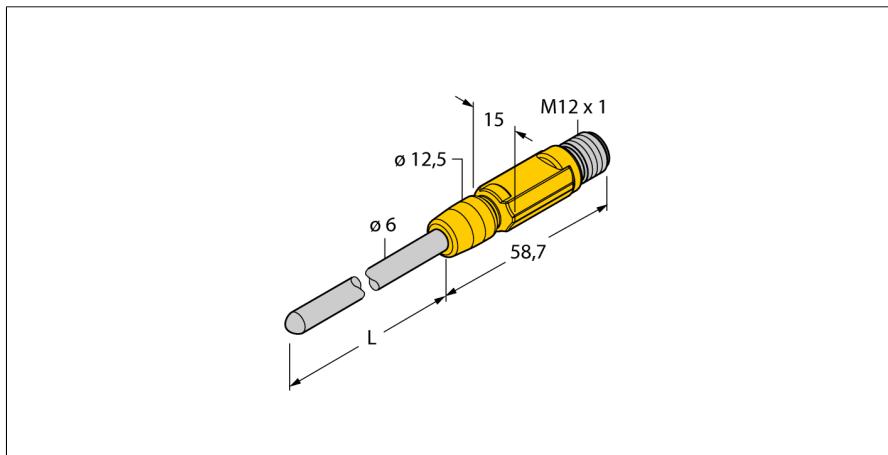

Type code	TTM150C-206A-CF-LI6-H1140-L200
Ident no.	9910560
Temperature range	0...150 °C
Temperature operating range	32...302°F
Measuring element	Pt-100 platinum measuring element, DIN EN 60751
Accuracy	Class A
Response time	t0.5 = 6 s/ t0.9 = 15 s in water at 0.2 m/s
Immersion depth (L)	200 mm
Power supply	
Operating voltage	10...24VDC
No-load current I ₀	≤ 20 mA
Short-circuit/reverse polarity protection	yes/ yes
Protection type and class	IP67/ III
Outputs	
Output 1	analog output
Analogue output	
Operating range	4...20 mA (2-wire)
Load	≤ 700 kΩ
Accuracy (Lin. + Hys. + Rep.)	± 0.2 K
Temperature behaviour	
Temperature coefficient zero point T ₀	± 0.1 % of full scale / 10 K
Temperature coefficient span T _{Δs}	± 0.1 % of full scale / 10 K
Ambient conditions	
Ambient temperature	-40...80 °C
Storage temperature	-40...+80°C
Pressure resistance	100 bar
Housing	
Housing material	stainless-steel/plastic, V4A (1.4404)
Sensor material	stainless steel, AISI 316L
Process connection	for compression fittings, thermowells or direct mounting
Connection	male, M12 x 1
Pressure resistance	100 bar
Reference conditions acc. to IEC 61298-1	
temperature	15...25 °C
Atmospheric pressure	860...1060 hPa abs.
Humidity	45...75 % rel.
Auxiliary power	24 VDC

**Temperature measurement
miniature transmitter with integrated probe
TTM150C-206A-CF-LI6-H1140-L200**

Wiring accessories

Type code	Ident no.	Description	Dimension drawing
RKC4.4T-2/TEL	6625013	Connection cable, female M12, straight, 4-pin, cable length: 2 m, sheath material: PVC, black; cULus approval; other cable lengths and qualities available, see www.turck.com	
WKC4.4T-2/TEL	6625025	Connection cable, female M12, angled, 4-pin, cable length: 2 m, sheath material: PVC, black; cULus approval; other cable lengths and qualities available, see www.turck.com	
RKC4.4T-2/TXL	6625503	Connection cable, female M12, straight, 4-pin, cable length: 2 m, sheath material: PUR, black; cULus approval; other cable lengths and qualities available, see www.turck.com	
WKC4.4T-2/TXL	6625515	Connection cable, female M12, angled, 4-pin, cable length: 2 m, sheath material: PUR, black; cULus approval; other cable lengths and qualities available, see www.turck.com	