

Flow sensor
Immersion sensor without integrated processor
FCS-G1/2HC4-NA-H1141

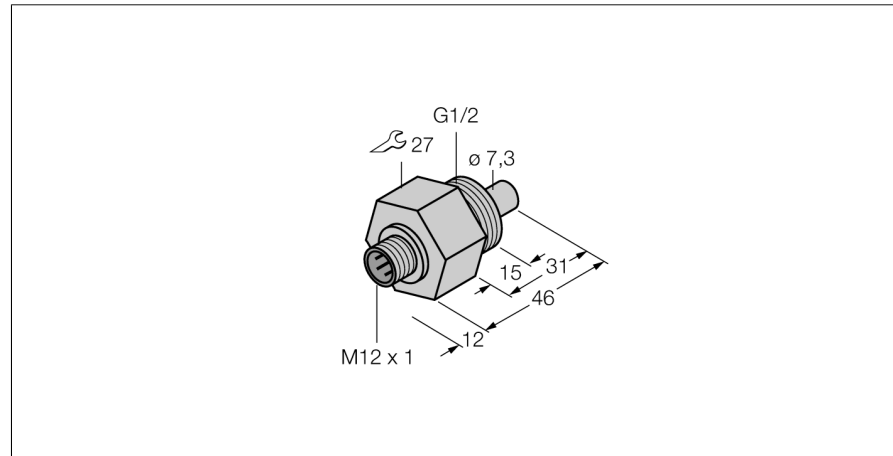

- Flow sensor for liquid media
- Calorimetric principle
- Adjustment via potentiometer on processor
- Status indicated via LED chain on signal processor
- Sensor made of Hastelloy C4
- Plug-in device, M12 x 1
- 4-wire connection to the processor

Wiring diagram

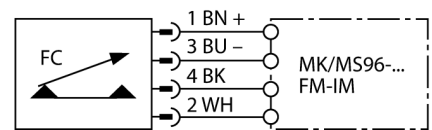

Functional principle

Our insertion - flow sensors operate on the principle of thermodynamics. The measuring probe is heated by several °C as against the flow medium. When fluid moves along the probe, the heat generated in the probe is dissipated. The resulting temperature is measured and compared to the medium temperature. The flow status of every medium can be derived from the evaluated temperature difference. Thus TURCK's wear-free flow sensors reliably monitor the flow of gaseous and liquid media.

Type code	FCS-G1/2HC4-NA-H1141
Ident no.	6870379
Operating range water	1...150cm/s
Oil operating range	3...300 cm/s
Stand-by time	typ. 8 s (2...15 s)
Switch-on time	typ. 2 s (1...13 s)
Switch-off time	typ. 2 s (1...15 s)
Temperature jump, response time	max. 12 s
Temperature gradient	≤ 250 K/min
Medium temperature	- 20...80 °C
Protection class	IP67
Housing material	metal, Hastelloy C4 (2.4610)
Sensor material	metal, Hastelloy C4 (2.4610)
Max. tightening torque housing nut	100 Nm
Connection	male, M12 x 1
Pressure resistance	100 bar
Process connection	G 1/2"

Flow sensor
Immersion sensor without integrated processor
FCS-G1/2HC4-NA-H1141

Wiring accessories

Type code	Ident no.	Description	Dimension drawing
RKC4.4T-2/TXL	6625503	Connection cable, female M12, straight, 4-pin, cable length: 2 m, sheath material: PUR, black; cULus approval; other cable lengths and qualities available, see www.turck.com	
WKC4.4T-2/TXL	6625515	Connection cable, female M12, angled, 4-pin, cable length: 2 m, sheath material: PUR, black; cULus approval; other cable lengths and qualities available, see www.turck.com	
RKC4.4T-2/TEL	6625013	Connection cable, female M12, straight, 4-pin, cable length: 2 m, sheath material: PVC, black; cULus approval; other cable lengths and qualities available, see www.turck.com	
WKC4.4T-2/TEL	6625025	Connection cable, female M12, angled, 4-pin, cable length: 2 m, sheath material: PVC, black; cULus approval; other cable lengths and qualities available, see www.turck.com	