

light screen for machine safety applications
emitter/receiver pair
SLSP30-1650Q88

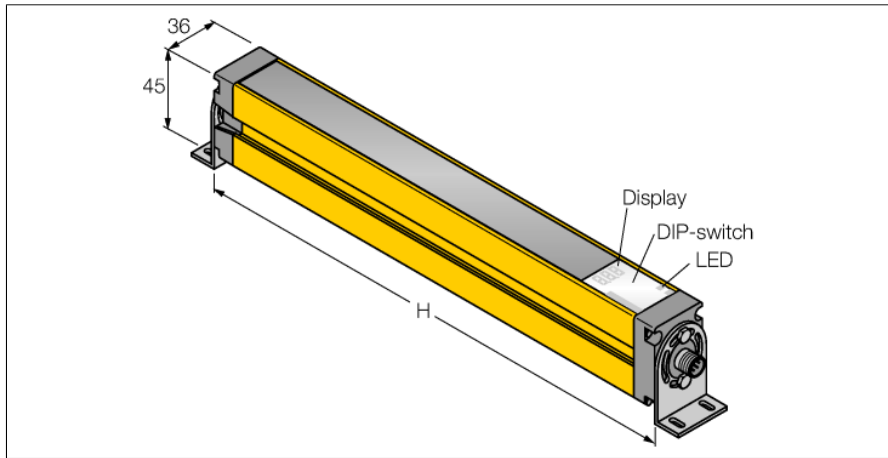

- Personnel safety Cat 4, PL e acc. to EN ISO 13849-1:2008
- Type 4 according to IEC 61496-1,-2
- SIL 3 to IEC 61508
- Emitter with male M12 x 1, 8-pin
- Receiver with male M12 x 1, 8-pin
- Blanking function
- Protection class IP65
- Adjustment via DIP switch
- Operating voltage 24 VDC +-15%
- Resolution 30 mm
- Scan field 1650 mm
- All devices incl. 2 EZA-MBK-11 mounting brackets; 900 mm devices and longer additionally incl. 1 EZA-MBK-12

Type code	SLSP30-1650Q88
Ident no.	3072397
Operating mode	light screen
Light type	IR
Wavelength	950 nm
Optical resolution	30 mm
Range	100...18000 mm
Detection zone height	1650 mm
Ambient temperature	0...+50 °C
Operating voltage	20...28VDC
Residual ripple	< 10 % U _s
No-load current I ₀	≤ 275 mA
Short-circuit protection	yes
Reverse polarity protection	yes
Output function	2x NC, 2 x PNP
Current output	0...500mA
Response time	< 30 ms
Design	rectangular, EZ-Screen
Dimensions	45 x 36 x 1719 mm
Housing material	metal, AL, yellow
Lens	plastic, acrylic
Connection	male, M12 x 1
Protection class	IP65
Power-on indication	LED green
Switching state	2-color LED red

Wiring diagram

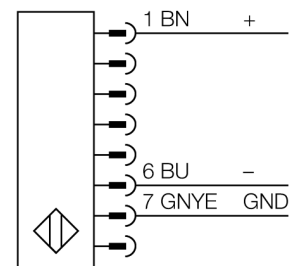
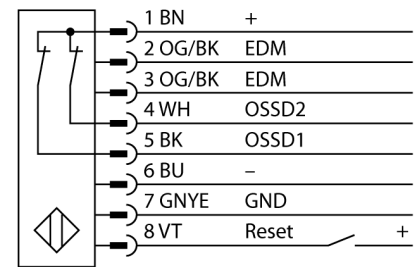

Functional principle

The high-resolution safety light screen for personnel protection consists of an emitter and a receiver. The system is optically synchronized, making the wiring between emitter and receiver redundant. The receiver's safety switching outputs are directly connected to a load relay and trigger an immediate stop of the dangerous machine cycle. Personnel safety degree type 4 acc. to IEC 61496 is fulfilled through 2 channel monitoring of the switching device and the multiple-redundant construction with mutual processor control.

**light screen for machine safety applications
emitter/receiver pair
SLSP30-1650Q88**

Accessories

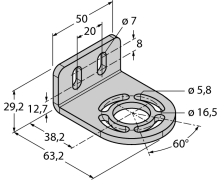
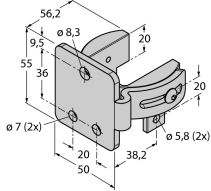
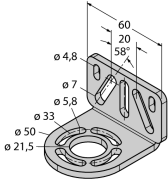
Type code	Ident no.	Description	Dimension drawing
EZA-MBK-11	3071470	Mounting bracket, steel, black-finished, for EZ-ARRAY and EZ-SCREEN standard and cascade 14 & 30 mm	
EZA-MBK-12	3071756	Mounting bracket, steel, black-finished, for EZ-ARRAY and EZ-SCREEN standard and cascade 14 & 30 mm	
EZA-MBK-20	3072587	Mounting bracket, steel, black-finished, for EZ-ARRAY and EZ-SCREEN standard 14 & 30 mm	

Wiring accessories

Type code	Ident no.	Description	Dimension drawing
QDE-815D	3070883	Connection cable, PVC, yellow, length: 4.57 m, female M12 x 1, 8-pin	
QDE-825D	3070884	Connection cable, PVC, yellow, length: 7.62 m, female M12 x 1, 8-pin	

light screen for machine safety applications
emitter/receiver pair
SLSP30-1650Q88

TURCK

Industrial
Automation

Wiring accessories

Type code	Ident no.	Description	Dimension drawing
QDE-850D	3070885	Connection cable, PVC, yellow, length: 15.3 m, female M12 x 1, 8-pin	
QDE-875D	3071466	Connection cable, PVC, yellow, length: 22.9 m, female M12 x 1, 8-pin	
QDE-8100D	3071467	Connection cable, PVC, yellow, length: 30.5 m, female M12 x 1, 8-pin	
DEE2R-81D	3072205	Connection cable, PVC, yellow, length: 0.31 m, female M12 x 1 - male M12, 8-pin	
DEE2R-83D	3072206	Connection cable, PVC, yellow, length: 0.91 m, female M12 x 1 - male M12, 8-pin	
DEE2R-88D	3072635	Connection cable, PVC, yellow, length: 2.44 m, female M12 x 1 - male M12, 8-pin	
DEE2R-815D	3072207	Connection cable, PVC, yellow, length: 4.57 m, female M12 x 1 - male M12, 8-pin	
DEE2R-825D	3072208	Connection cable, PVC, yellow, length: 7.62 m, female M12 x 1 - male M12, 8-pin	
DEE2R-850D	3072209	Connection cable, PVC, yellow, length: 15.2 m, female M12 x 1 - male M12, 8-pin	
DEE2R-875D	3072210	Connection cable, PVC, yellow, length: 22.9 m, female M12 x 1 - male M12, 8-pin	
DEE2R-8100D	3072211	Connection cable, PVC, yellow, length: 30.5 m, female M12 x 1 - male M12, 8-pin	
CSB-M1280M1280	3075375	Y-piece, PVC, yellow, with male M12 x 1, 8-pin on 2 x 0.3 m cable, PVC, yellow, with female M12 x 1, 8-pin	
CSB-M1281M1281	3073252	Y-piece, PVC, yellow, length: 0.3 m with male, M12 x 1, 8-pin on 2 x 0.3 m cable, PVC, yellow, with female, M12 x 1, 8-pin	
CSB-M1288M1281	3073253	Y-piece, PVC, yellow, length: 2.5 m with male, M12 x 1, 8-pin on 2 x 0.3 m cable, PVC, yellow, with female, M12 x 1, 8-pin	
CSB-M12815M1281	3073254	Y-piece, PVC, yellow, length: 4.6 m with male, M12 x 1, 8-pin on 2 x 0.3 m cable, PVC, yellow, with female, M12 x 1, 8-pin	
CSB-M12825M1281	3073255	Y-piece, PVC, yellow, length: 7.6 m with male, M12 x 1, 8-pin on 2 x 0.3 m cable, PVC, yellow, with female, M12 x 1, 8-pin	