

**light screen for machine safety applications**  
**receiver**  
**LS2TR30-450Q8**

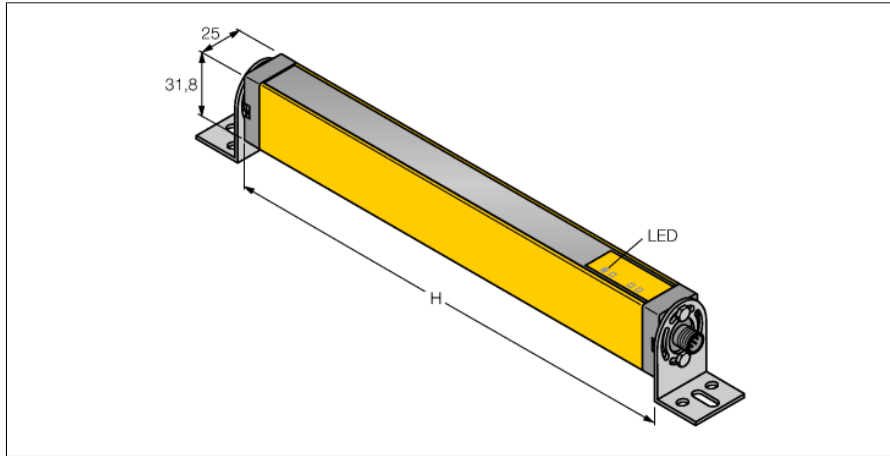

- Type 2 acc. to IEC 61496-1,-2; category 2 PLd acc. to EN ISO 13849-1; SIL2 acc. to IEC 61508
- Male M12 x 1, 8-pin
- Protection class IP65
- Scan field 450 mm
- Resolution 30 mm
- Internal testing in 500 ms cycle
- Range 15 m
- Operating voltage 24 VDC +/-15%
- Switching output without TRIP

**Wiring diagram**

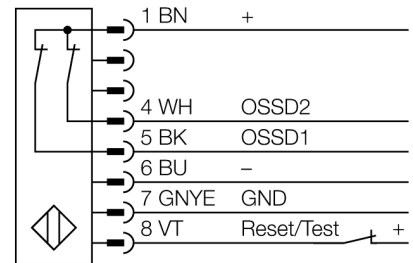

**Functional principle**

The safety light curtain consists of an emitter and a receiver. The system is optically synchronized, making the wiring between emitter and receiver redundant. The receiver's safety switching outputs are directly connected to a load relay and trigger an immediate stop of the dangerous machine cycle. Due to the dual-channel design of the switching device, personal safety degree type 2 acc. to IEC 61496 and category 2 acc. to EN 9541 are fulfilled.

<b>Type code</b>	LS2TR30-450Q8
Ident no.	3073536
<b>Operating mode</b>	light screen
Optical resolution	30 mm
Range	200...15000 mm
Detection zone height	450 mm
Ambient temperature	0...+55 °C
<b>Operating voltage</b>	20...28VDC
Residual ripple	< 15 % U <sub>s</sub>
No-load current I <sub>0</sub>	≤ 90 mA
Output function	2x NC, 2 x PNP
Response time	< 14 ms
<b>Design</b>	rectangular, EZ-Screen
Dimensions	31.8 x 25.2 x 515 mm
Housing material	metal, AL, yellow
Lens	plastic, acrylic
Connection	male, M12 x 1
Protection class	IP65
<b>Power-on indication</b>	LED green
Switching state	LED red