

**Personnel safety, light screen
receiver
SLPR14-690P8**

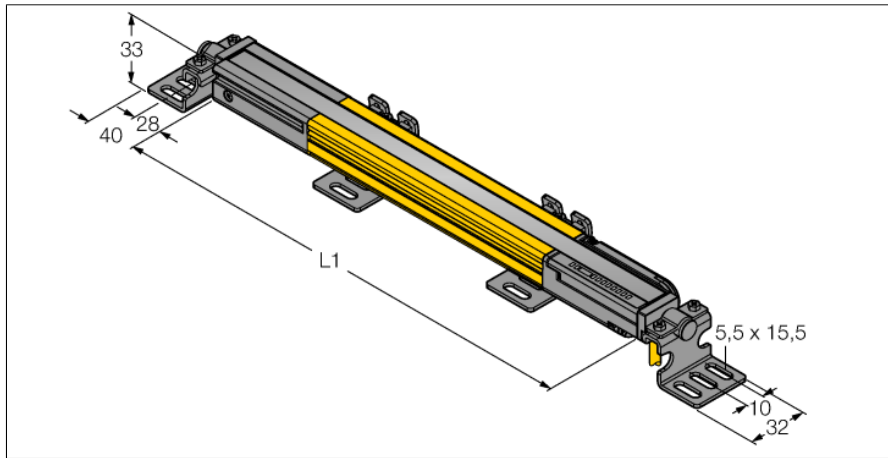

- Personnel safety Cat 4, PL e acc. to EN ISO 13849-1:2008
- Type 4 according to IEC 61496-1,-2
- SIL 3 to IEC 61508
- Cable with male end M12 x 1, 8-pin, 300 mm
- Protection class IP65
- Flat housing without blind zone
- Adjustment via DIP switch
- Resolution can be reduced
- Blanking function
- Operating voltage: 24 VDC ± 15 %
- Resolution 14 mm
- Scan field 690 mm (L1)

Type code	SLPR14-690P8
Ident no.	3083555
Operating mode	light screen
Optical resolution	14 mm
Range	0...7000 mm
Detection zone height	690 mm
Ambient temperature	0...+55 °C
Operating voltage	20...28VDC
Residual ripple	< 10 % U _{ss}
Non-actuated current consumption	≤ 150 mA
No-load current I ₀	≤ 275 mA
Short-circuit protection	yes
Reverse polarity protection	yes
Output function	2x NC, 2 x PNP
Current output	0...500mA
Response time	< 19.5 ms
Design	rectangular, EZ-Screen LP
Dimensions	26 x 28 x 689 mm
Housing material	metal, AL, yellow
Lens	plastic, acrylic
Connection	cable with connector, PVC, M12 x 1
Cable length	300 m
Protection class	IP65
Power-on indication	LED green
Switching state	2-color LED red

Wiring diagram

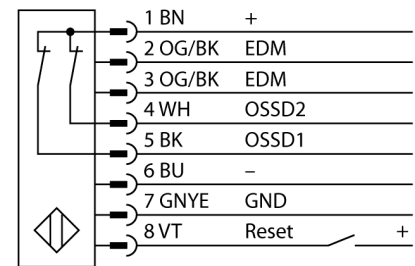

Functional principle

The high-resolution safety light curtain is emitter and receiver in one without blind zone. As the system is synchronized optically, wiring between emitter and receiver is redundant. The safety switching outputs of the receiver are directly connected to a load relay (e.g. IM-TA9A) and trigger an immediate stop of the dangerous machine cycle. The switching device with 2-channel monitoring, diverse redundant designed and mutual processor control, complies with the personnel safety category PLe acc. to ISO 13849-1.

**Personnel safety, light screen
receiver
SLPR14-690P8**

TURCK

Industrial
Automation

Accessories

Type code	Ident no.	Description	Dimension drawing
LPA-MBK-11	3082841	Mounting bracket, retainer for closure caps, 14-ga. steel, galvanized, black, 360 ° sensor rotation, incl.2 pcs. with screw set	
LPA-MBK-12	3082842	Mounting bracket, side mounting, 14-ga. steel, galvanized, black, +10°/-30° sensor rotation, incl.1 pcs. with screw set	
LPA-MBK-20	3082853	Mounting bracket, wall mounting, 12-ga. steel, galvanized, black, in combination with LPA-MBK-11/ -12/ -13, incl. 1 pcs. and screw set	
LPA-MBK-22	3082844	Mounting bracket, wall mounting, 14-ga. steel, galvanized, black, in combination with LPA-MBK-11, incl. 2 pcs. and screw set	

Wiring accessories

Type code	Ident no.	Description	Dimension drawing
DEE2R-81D	3072205	Connection cable, PVC, yellow, length: 0.31 m, female M12 x 1 - male M12, 8-pin	
DEE2R-83D	3072206	Connection cable, PVC, yellow, length: 0.91 m, female M12 x 1 - male M12, 8-pin	
DEE2R-88D	3072635	Connection cable, PVC, yellow, length: 2.44 m, female M12 x 1 - male M12, 8-pin	
DEE2R-815D	3072207	Connection cable, PVC, yellow, length: 4.57 m, female M12 x 1 - male M12, 8-pin	
DEE2R-825D	3072208	Connection cable, PVC, yellow, length: 7.62 m, female M12 x 1 - male M12, 8-pin	
DEE2R-850D	3072209	Connection cable, PVC, yellow, length: 15.2 m, female M12 x 1 - male M12, 8-pin	
DEE2R-875D	3072210	Connection cable, PVC, yellow, length: 22.9 m, female M12 x 1 - male M12, 8-pin	
DEE2R-8100D	3072211	Connection cable, PVC, yellow, length: 30.5 m, female M12 x 1 - male M12, 8-pin	
QDE-815D	3070883	Connection cable, PVC, yellow, length: 4.57 m, female M12 x 1, 8-pin	
QDE-825D	3070884	Connection cable, PVC, yellow, length: 7.62 m, female M12 x 1, 8-pin	

**Personnel safety, light screen
receiver
SLPR14-690P8**

TURCK

Industrial
Automation

Wiring accessories

Type code	Ident no.	Description	Dimension drawing
QDE-850D	3070885	Connection cable, PVC, yellow, length: 15.3 m, female M12 x 1, 8-pin	
QDE-875D	3071466	Connection cable, PVC, yellow, length: 22.9 m, female M12 x 1, 8-pin	
QDE-8100D	3071467	Connection cable, PVC, yellow, length: 30.5 m, female M12 x 1, 8-pin	
CSB-M1280M1280	3075375	Y-piece, PVC, yellow, with male M12 x 1, 8-pin on 2 x 0.3 m cable, PVC, yellow, with female M12 x 1, 8-pin	
CSB-M1281M1281	3073252	Y-piece, PVC, yellow, length: 0.3 m with male, M12 x 1, 8-pin on 2 x 0.3 m cable, PVC, yellow, with female, M12 x 1, 8-pin	
CSB-M1288M1281	3073253	Y-piece, PVC, yellow, length: 2.5 m with male, M12 x 1, 8-pin on 2 x 0.3 m cable, PVC, yellow, with female, M12 x 1, 8-pin	
CSB-M12815M1281	3073254	Y-piece, PVC, yellow, length: 4.6 m with male, M12 x 1, 8-pin on 2 x 0.3 m cable, PVC, yellow, with female, M12 x 1, 8-pin	
CSB-M12825M1281	3073255	Y-piece, PVC, yellow, length: 7.6 m with male, M12 x 1, 8-pin on 2 x 0.3 m cable, PVC, yellow, with female, M12 x 1, 8-pin	