

**Personnel safety, light screen
receiver
SLPR25-1810**

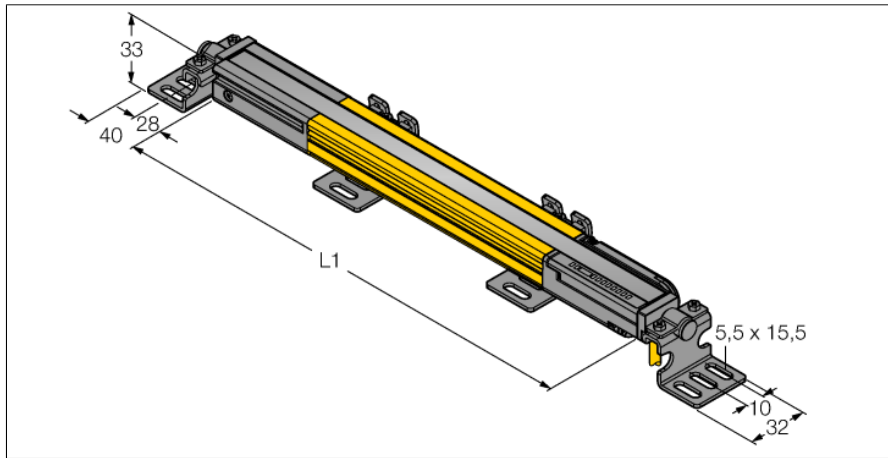

- Personnel safety Cat 4, PL e acc. to EN ISO 13849-1:2008
- Type 4 according to IEC 61496-1,-2
- SIL 3 to IEC 61508
- Electrical connection via RDLP-8 with open end or via DELPE-8 with male M12 x 1, 8-pin
- Protection class IP65
- Flat housing without blind zone
- Adjustment via DIP switch
- Resolution can be reduced
- Blanking function
- Operating voltage: 24 VDC ± 15 %
- Resolution 25 mm
- Scan field 1810 mm (L1)

Type code	SLPR25-1810
Ident no.	3083679
Operating mode	light screen
Optical resolution	25 mm
Range	0...7000 mm
Detection zone height	1810 mm
Ambient temperature	0...+55 °C
Operating voltage	20...28VDC
Residual ripple	< 10 % U _{ss}
Non-actuated current consumption	≤ 150 mA
No-load current I ₀	≤ 275 mA
Short-circuit protection	yes
Reverse polarity protection	yes
Output function	2x NC, 2 x PNP
Current output	0...500mA
Response time	< 24 ms
Design	rectangular, EZ-Screen LP
Dimensions	26 x 28 x 1807 mm
Housing material	metal, AL, yellow
Lens	plastic, acrylic
Connection	male
Protection class	IP65
Power-on indication	LED green
Switching state	2-color LED red

Wiring diagram



Functional principle

The high-resolution safety light curtain is emitter and receiver in one without blind zone. As the system is synchronized optically, wiring between emitter and receiver is redundant. The safety switching outputs of the receiver are directly connected to a load relay (e.g. IM-TA9A) and trigger an immediate stop of the dangerous machine cycle. The switching device with 2-channel monitoring, diverse redundant designed and mutual processor control, complies with the personnel safety category PLe acc. to ISO 13849-1.

**Personnel safety, light screen
receiver
SLPR25-1810**

TURCK

Industrial
Automation

Accessories

Type code	Ident no.	Description	Dimension drawing
LPA-MBK-11	3082841	Mounting bracket, retainer for closure caps, 14-ga. steel, galvanized, black, 360 ° sensor rotation, incl.2 pcs. with screw set	
LPA-MBK-12	3082842	Mounting bracket, side mounting, 14-ga. steel, galvanized, black, +10°/-30° sensor rotation, incl.1 pcs. with screw set	
LPA-MBK-20	3082853	Mounting bracket, wall mounting, 12-ga. steel, galvanized, black, in combination with LPA-MBK-11/ -12/ -13, incl. 1 pcs. and screw set	
LPA-MBK-22	3082844	Mounting bracket, wall mounting, 14-ga. steel, galvanized, black, in combination with LPA-MBK-11, incl. 2 pcs. and screw set	

Wiring accessories

Type code	Ident no.	Description	Dimension drawing
RDLP-815D	3080792	Connection cable, PVC, yellow, length: 4.57 m, RD connector for direct connection to the light screen	
RDLP-825D	3080793	Connection cable, PVC, yellow, length: 7.62 m, RD connector for direct connection to the light screen	
RDLP-850D	3080794	Connection cable, PVC, yellow, length: 15.2 m, RD connector for direct connection to the light screen	
RDLP-875D	3080795	Connection cable, PVC, yellow, length: 22.9 m, RD connector for direct connection to the light screen	
DELPE-81D	3080811	Connection cable, PVC, yellow, length: 0.31 m, RD connector for direct connection on male M12 x 1, 8-pin,	
DELPE-83D	3080812	Connection cable, PVC, yellow, length: 0.91 m, RD connector for direct connection on male M12 x 1, 8-pin,	
DELPE-88D	3080813	Connection cable, PVC, yellow, length: 2.44 m, RD connector for direct connection on male M12 x 1, 8-pin,	
DELPE-815D	3080814	Connection cable, PVC, yellow, length: 4.57 m, RD connector for direct connection on male M12 x 1, 8-pin,	
DELPE-825D	3080815	Connection cable, PVC, yellow, length: 7.62 m, RD connector for direct connection on male M12 x 1, 8-pin,	
DELPE-850D	3080816	Connection cable, PVC, yellow, length: 15.2 m, RD connector for direct connection on male M12 x 1, 8-pin,	
DELPE-875D	3080817	Connection cable, PVC, yellow, length: 22.9 m, RD connector for direct connection on male M12 x 1, 8-pin,	
DELPE-8100D	3080818	Connection cable, PVC, yellow, length: 30.5 m, RD connector for direct connection on male M12 x 1, 8-pin,	
CSB-M1280M1280	3075375	Y-piece, PVC, yellow, with male M12 x 1, 8-pin on 2 x 0.3 m cable, PVC, yellow, with female M12 x 1, 8-pin	
CSB-M1281M1281	3073252	Y-piece, PVC, yellow, length: 0.3 m with male, M12 x 1, 8-pin on 2 x 0.3 m cable, PVC, yellow, with female, M12 x 1, 8-pin	
CSB-M1288M1281	3073253	Y-piece, PVC, yellow, length: 2.5 m with male, M12 x 1, 8-pin on 2 x 0.3 m cable, PVC, yellow, with female, M12 x 1, 8-pin	
CSB-M12815M1281	3073254	Y-piece, PVC, yellow, length: 4.6 m with male, M12 x 1, 8-pin on 2 x 0.3 m cable, PVC, yellow, with female, M12 x 1, 8-pin	
CSB-M12825M1281	3073255	Y-piece, PVC, yellow, length: 7.6 m with male, M12 x 1, 8-pin on 2 x 0.3 m cable, PVC, yellow, with female, M12 x 1, 8-pin	