

**Personnel safety  
receiver  
integrated muting function  
SLPMR14-550P12**

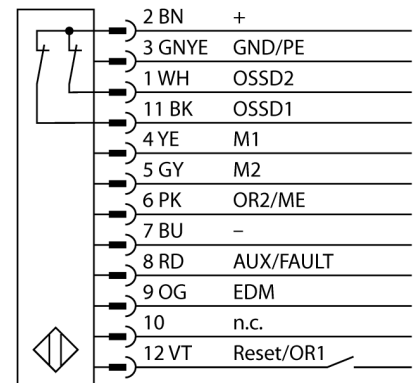

- Cable with male end M12 x 1, 8-pin, 300 mm
- Protection class IP65
- Flat housing without blind zone
- Adjustments via DIP switch
- Resolution can be reduced
- Blanking function
- Operating voltage: 24 VDC ± 15 %
- Resolution 14 mm
- Scan field 550 mm (L1)
- Mounting bracket included in delivery

**Wiring diagram**



**Functional principle**

The high-resolution safety light screen is emitter and receiver in one without blind zone. As the system is optically synchronized, emitter/receiver wiring is superfluous. The receiver's safety switching outputs are directly connected to a load relay (e.g. IM-T-9A) and trigger an immediate stop of dangerous machine cycles. Personnel safety category PLe acc. to ISO 13849-1 is fulfilled through 2-channel monitoring of the switching device and the principle of diverse redundancy by which two processors control each other mutually.

<b>Type code</b>	SLPMR14-550P12
Ident no.	3084454
<b>Operating mode</b>	light screen
Optical resolution	14 mm
Range	0...7000 mm
Detection zone height	550 mm
Ambient temperature	0...+55 °C
<b>Operating voltage</b>	20...28VDC
Residual ripple	< 10 % U <sub>ss</sub>
Non-actuated current consumption	≤ 150 mA
No-load current I <sub>0</sub>	≤ 275 mA
Short-circuit protection	yes
Reverse polarity protection	yes
Output function	2x NC, 2 x PNP
Current output	0...500mA
Response time	< 16.5 ms
<b>Design</b>	rectangular, EZ-Screen LP
Dimensions	26 x 28 x 549 mm
Housing material	metal, AL, yellow
Lens	plastic, Acryl
Connection	cable with connector, PVC, M12 x 1
Cable length	0.3 m
Protection class	IP65
<b>Power-on indication</b>	LED green
Switching state	2-color LED red