



M20Z-02550A221

M2000 RES/EDM A/P

MULTIPLE LIGHT BEAM SAFETY DEVICES

SICK
Sensor Intelligence.



Illustration may differ



Ordering information

System part	Type	Part no.
Sender/receiver in one housing	M20Z-02550A221	1018239

Important notes: 1.) Concerns installation as a spare part: This type 2 device may be used as per section 1, paragraph (2a) of Machinery Directive 2006/42/EC within the EU as a spare part for identical PL d/SIL2 devices only if the machine was put on the market before 10/5/2015. Keep this note with your machine documentation. If the machine is resold, this note must be passed on to the next buyer. 2.) Concerns installation in new machines: Due to the amendment to the EN/IEC 61496-1 standard, this type 2 device may only be installed on new machines up to PLc/SIL1 as of 5/10/2015.

Other models and accessories → www.sick.com/M2000_RES_EDM_A_P

Detailed technical data

Safety-related parameters

Type	Type 2 (IEC 61496-1)
Safety integrity level	SIL1 (IEC 61508) SILCL1 (EN 62061)
Category	Category 2 (EN ISO 13849)
Test rate (internal test)	13 /s (EN ISO 13849) ¹⁾
Maximum demand rate	≤ 8 min ⁻¹ (EN ISO 13849) ²⁾
Performance level	PL c (EN ISO 13849)
PFH_D (mean probability of a dangerous failure per hour)	6.6 x 10 ⁻⁹ (EN ISO 13849)
T_M (mission time)	20 years (EN ISO 13849)
Safe state in the event of a fault	At least one OSSD is in the OFF state.

¹⁾ Internal test. The test rate may not be exceeded if an external test is performed.

²⁾ Between two requirements on a safety-related response of the device, at least 100 internal or external tests must be carried out.

Functions

Beam coding	✓
Restart interlock	✓

Interfaces

System connection	Hirschmann male connector M26, 12-pin
Conductor cross-section	1 mm ²
Configuration method	Hard wired
Display elements	LEDs 7-segment display
Fieldbus, industrial network	
Integration via Flexi Soft safety controller	CANopen ¹⁾ DeviceNet™ EtherCAT®

¹⁾ For additional information on Flexi Soft -> www.sick.com/Flexi_Soft.

EtherNet/IP™ Modbus TCP PROFIBUS DP PROFINET

¹⁾ For additional information on Flexi Soft -> www.sick.com/Flexi_Soft.

Electrical data

Protection class	III (IEC 61140)
Supply voltage V_s	24 V DC (19.2 V DC ... 28.8 V DC) ¹⁾
Output signal switching devices (OSSDs)	2 PNP semiconductors, short-circuit protected, cross-circuit monitored

¹⁾ The external voltage supply must be capable of buffering brief mains voltage failures of 20 ms as specified in EN 60204-1. Suitable power supplies are available as accessories from SICK.

Mechanical data

Dimensions	See dimensional drawing
Housing cross-section	48 mm x 40 mm

Ambient data

Enclosure rating	IP65 (EN 60529)
Air humidity	15 % ... 95 %, Non-condensing
Shock resistance	10 g, 16 ms (IEC 60068-2-29)

Other information

Wave length	950 nm
--------------------	--------

Classifications

ECl@ss 5.0	27272703
ECl@ss 5.1.4	27272703
ECl@ss 6.0	27272703
ECl@ss 6.2	27272703
ECl@ss 7.0	27272703
ECl@ss 8.0	27272703
ECl@ss 8.1	27272703
ECl@ss 9.0	27272703
ECl@ss 10.0	27272703
ECl@ss 11.0	27272703
ETIM 5.0	EC001832
ETIM 6.0	EC001832
ETIM 7.0	EC001832
UNSPSC 16.0901	46171620



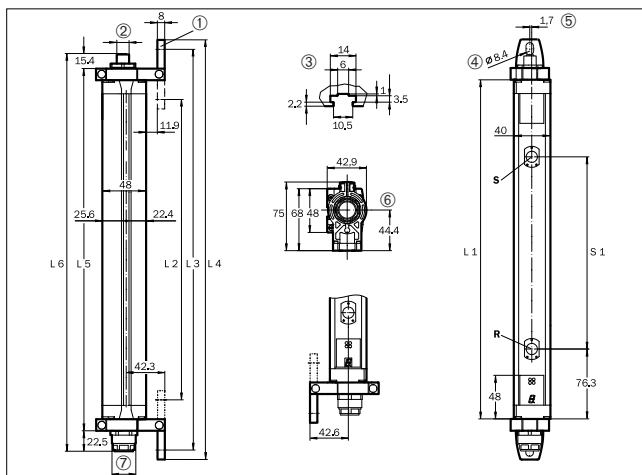



Dimensional drawing (Dimensions in mm (inch))



N	S1	L1	L2	L3	L4	L5	L6
2	500	653	611	720	741	678	716
Dimensions in mm (inch)							

Recommended accessories

Other models and accessories → www.sick.com/M2000_RES_EDM_A_P

Brief description		Type	Part no.
Mounting brackets and plates			
	4 pieces, Mounting kit 1, mounting bracket, rigid, L-shaped, including fixing screws and washers	BEF-3WNGBAST4	7021352
Terminal and alignment brackets			
	4 pieces, Mounting kit 6, side bracket, rotatable, zinc diecast	BEF-1SHABAZN4	2019506
	4 pieces, Omega bracket, rotatable, fixable with only one screw, for mounting on the swivel mount	BEF-2SMMEAAL4	2044847
	4 pieces, Mounting kit 2, rotatable, swivel mount, Polyamide PA6	BEF-2SMMEAUK4	2019659
Alignment aids			
	Laser alignment aid for various sensors, laser class 2 (IEC 60825). Do not look into the beam!	AR60	1015741
	Adapter AR60 for housing cross-section 48 mm x 40 mm	AR60 adapter, 48x40	4032461

	Brief description	Type	Part no.
	Adapter AR60 for housing cross-section 48 mm x 40 mm in PU3H device column	AR60 adapter, 48x40, PU3H	4056731

SICK AT A GLANCE

SICK is one of the leading manufacturers of intelligent sensors and sensor solutions for industrial applications. A unique range of products and services creates the perfect basis for controlling processes securely and efficiently, protecting individuals from accidents and preventing damage to the environment.

We have extensive experience in a wide range of industries and understand their processes and requirements. With intelligent sensors, we can deliver exactly what our customers need. In application centers in Europe, Asia and North America, system solutions are tested and optimized in accordance with customer specifications. All this makes us a reliable supplier and development partner.

Comprehensive services complete our offering: SICK LifeTime Services provide support throughout the machine life cycle and ensure safety and productivity.

For us, that is “Sensor Intelligence.”

WORLDWIDE PRESENCE:

Contacts and other locations –www.sick.com