



# DFS60B-TEEK02048

DFS60

INCREMENTAL ENCODERS

**SICK**  
Sensor Intelligence.



Illustration may differ



### Ordering information

Type	Part no.
DFS60B-TEEK02048	1070135

Other models and accessories → [www.sick.com/DFS60](http://www.sick.com/DFS60)

### Detailed technical data

#### Performance

<b>Pulses per revolution</b>	2,048 <sup>1)</sup>
<b>Measuring step</b>	90° electric/pulses per revolution
<b>Measuring step deviation at binary number of lines</b>	± 0.008°
<b>Error limits</b>	± 0.05°

<sup>1)</sup> See maximum revolution range.

#### Interfaces

<b>Communication interface</b>	Incremental
<b>Communication Interface detail</b>	HTL / Push pull
<b>Number of signal channels</b>	6-channel
<b>Initialization time</b>	40 ms
<b>Output frequency</b>	≤ 600 kHz
<b>Load current</b>	≤ 30 mA
<b>Power consumption</b>	≤ 0.5 W (without load)
<b>4.5 V... 5.5 V, TTL/RS-422</b>	
Load current	≤ 30 mA
<b>4.5 V ... 5.5 V, Open Collector</b>	
Load current	≤ 30 mA
<b>TTL/RS-422</b>	
Load current	≤ 30 mA
Power consumption	≤ 0.5 W (without load)
<b>HTL/Push pull</b>	
Load current	≤ 30 mA
Power consumption	≤ 0.5 W (without load)
<b>TTL/HTL</b>	
Load current	≤ 30 mA
Power consumption	≤ 0.5 W (without load)

<b>Open Collector</b>	Load current	≤ 30 mA
	Power consumption	≤ 0.5 W (without load)

#### Electrical data

<b>Connection type</b>	Cable, 8-wire, universal, 1.5 m <sup>1)</sup>
<b>Supply voltage</b>	10 ... 32 V
<b>Reference signal, number</b>	1
<b>Reference signal, position</b>	90°, electric, logically gated with A and B
<b>Reverse polarity protection</b>	✓
<b>Short-circuit protection of the outputs</b>	✓ <sup>2)</sup>
<b>MTTFd: mean time to dangerous failure</b>	300 years (EN ISO 13849-1) <sup>3)</sup>

<sup>1)</sup> The universal cable connection is positioned so that it is possible to lay it without bends in a radial or axial direction.

<sup>2)</sup> Short-circuit opposite to another channel, US or GND permissible for maximum 30 s.

<sup>3)</sup> This product is a standard product and does not constitute a safety component as defined in the Machinery Directive. Calculation based on nominal load of components, average ambient temperature 40 °C, frequency of use 8760 h/a. All electronic failures are considered hazardous. For more information, see document no. 8015532.

#### Mechanical data

<b>Mechanical design</b>	Through hollow shaft
<b>Shaft diameter</b>	12 mm
<b>Weight</b>	+ 0.2 kg
<b>Shaft material</b>	Stainless steel
<b>Flange material</b>	Aluminum
<b>Housing material</b>	Aluminum die cast
<b>Start up torque</b>	0.8 Ncm (+20 °C)
<b>Operating torque</b>	0.6 Ncm (+20 °C)
<b>Permissible shaft movement, axial static/dynamic</b>	± 0.5 mm / ± 0.2 mm
<b>Permissible shaft movement, radial static/dynamic</b>	± 0.3 mm / ± 0.1 mm
<b>Operating speed</b>	≤ 6,000 min <sup>-1</sup> <sup>1)</sup>
<b>Moment of inertia of the rotor</b>	40 gcm <sup>2</sup>
<b>Bearing lifetime</b>	3.6 x 10 <sup>10</sup> revolutions
<b>Angular acceleration</b>	≤ 500,000 rad/s <sup>2</sup>

<sup>1)</sup> Allow for self-heating of 3.3 K per 1,000 rpm when designing the operating temperature range.

#### Ambient data

<b>EMC</b>	According to EN 61000-6-2 and EN 61000-6-4
<b>Enclosure rating</b>	IP65, housing side, cable connection (according to IEC 60529) IP65, shaft side (according to IEC 60529)
<b>Permissible relative humidity</b>	90 % (condensation of the optical scanning not permitted)
<b>Operating temperature range</b>	-40 °C ... +100 °C <sup>1)</sup> -30 °C ... +100 °C <sup>2)</sup>

<sup>1)</sup> Stationary position of the cable.

<sup>2)</sup> Flexible position of the cable.

<b>Storage temperature range</b>	-40 °C ... +100 °C, without package
<b>Resistance to shocks</b>	70 g, 6 ms (according to EN 60068-2-27)
<b>Resistance to vibration</b>	30 g, 10 Hz ... 2,000 Hz (according to EN 60068-2-6)

<sup>1)</sup> Stationary position of the cable.

<sup>2)</sup> Flexible position of the cable.

### Classifications

<b>ECl@ss 5.0</b>	27270501
<b>ECl@ss 5.1.4</b>	27270501
<b>ECl@ss 6.0</b>	27270590
<b>ECl@ss 6.2</b>	27270590
<b>ECl@ss 7.0</b>	27270501
<b>ECl@ss 8.0</b>	27270501
<b>ECl@ss 8.1</b>	27270501
<b>ECl@ss 9.0</b>	27270501
<b>ECl@ss 10.0</b>	27270501
<b>ECl@ss 11.0</b>	27270501
<b>ETIM 5.0</b>	EC001486
<b>ETIM 6.0</b>	EC001486
<b>ETIM 7.0</b>	EC001486
<b>UNSPSC 16.0901</b>	41112113

**Dimensional drawing** (Dimensions in mm (inch))

Through hollow shaft, cable

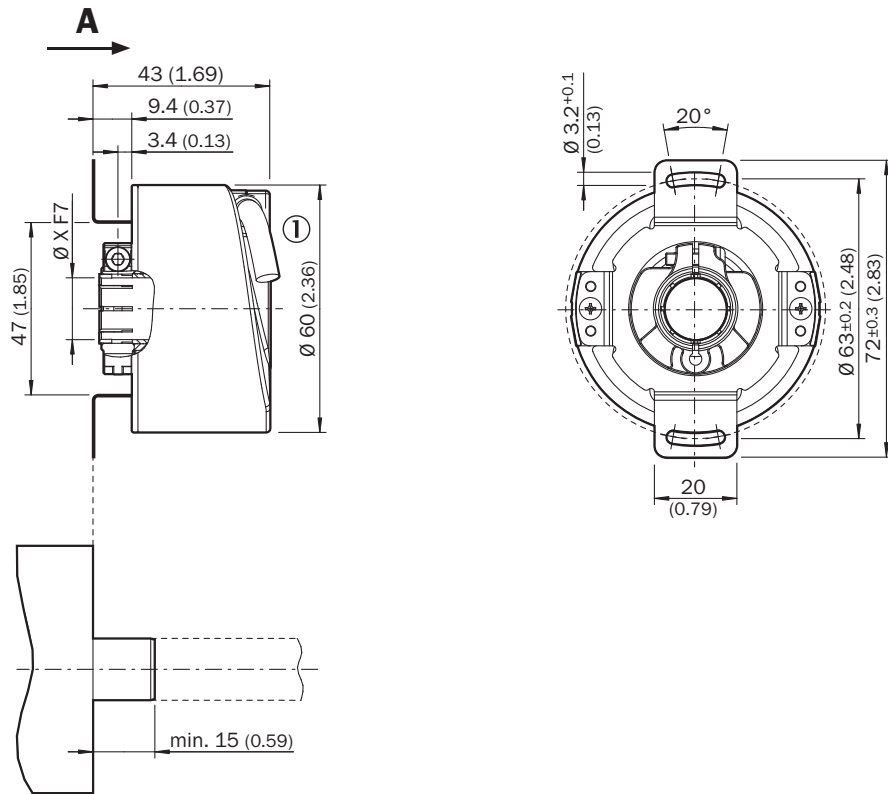

General tolerances according to DIN ISO 2768-mk

① Cable diameter = 5.6 mm +/- 0.2 mm bend radius = 30 mm

PIN assignment

**Cable, 8-wire**

View of M12 male device connector on encoder



View of M23 male device connector on encoder



PIN, 8-pin, M12 male connector	PIN, 12-pin, M23 male connector	Color of the wires for encoders with cable outlet	TTL/HTL signal	Sin/cos 1.0 V <sub>SS</sub>	Explanation
1	6	Brown	$\bar{A}$	COS-	Signal wire
2	5	White	A	COS+	Signal wire
3	1	Black	$\bar{B}$	SIN-	Signal wire
4	8	Pink	B	SIN+	Signal wire
5	4	Yellow	$\bar{Z}$	$\bar{Z}$	Signal wire
6	3	Violet	Z	Z	Signal wire
7	10	Blue	GND	GND	Ground connection of the encoder
8	12	Red	+U <sub>s</sub>	+U <sub>s</sub>	Supply voltage (volt-free to housing)
-	9	-	n.c.	n.c.	Not assigned
-	2	-	n.c.	n.c.	Not assigned
-	11	-	n.c.	n.c.	Not assigned
-	7 <sup>1)</sup>	-	O-SET <sup>1)</sup>	n.c.	Set zero pulse <sup>1)</sup>
Screen	Screen	Screen	Screen	Screen	Screen connected to housing on encoder side. Connected to ground on control side.

<sup>1)</sup> For electrical interfaces only: M, U, V, W with O-SET function on PIN 7 on M23 male connector. The O-SET input is used to set the zero pulse on the current shaft position. If the O-SET input is connected to U<sub>s</sub> for longer than 250 ms after it had previously been unassigned for at least 1,000 ms or had been connected to the GND, the current position of the shaft is assigned to the zero pulse signal "Z".

## Maximum revolution range

Maximum revolution range



## Signal outputs

Signal outputs



CW with view on the encoder shaft in direction "A", compare dimensional drawing.

Supply voltage	Output
4,5 V ... 5,5 V	TTL
10 V ... 32 V	TTL
10 V ... 32 V	HTL



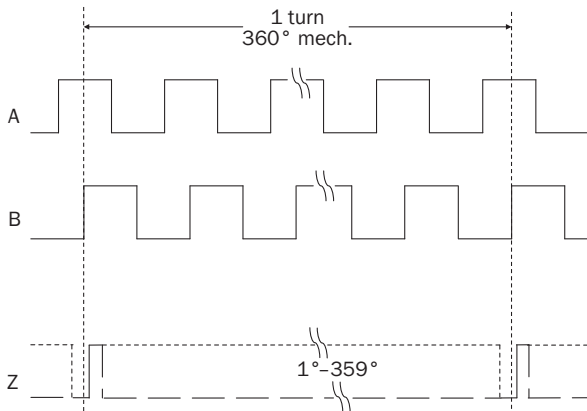

### Diagrams





Mechanical zero pulse width 1° to 359° programmable. Width of the zero pulse in relation to a mechanical revolution of the shaft.



### Recommended accessories

Other models and accessories → [www.sick.com/DFS60](http://www.sick.com/DFS60)

	Brief description	Type	Part no.
<b>Flanges</b>			
	Standard stator coupling	BEF-DS00XFX	2056812
<b>Other mounting accessories</b>			
	Bearing bracket for hollow shaft encoders, fastening screws included the Bearing Block is intended for very large radial and axial shaft loads. Particularly for application on: Belt pulleys, Chain pinions, Friction wheels. It is designed this way to enable fitting of encoder with blind hollow shaft with ø 12 mm., fastening screws included	BEF-FA-B12-010	2042728
	Clamping ring for metal hollow shaft, metal	BEF-KR-M	2064709
<b>Plug connectors and cables</b>			
	Head A: female connector, JST, 8-pin, straight Head B: Flying leads Cable: Incremental, SSI, PUR, halogen-free, shielded, 5 m	DOL-0J08-G05MAA3	2046876
	Head A: female connector, JST, 8-pin, straight Head B: Flying leads Cable: Incremental, SSI, PUR, halogen-free, shielded, 0.5 m	DOL-0J08-G0M5AA3	2046873
	Head A: female connector, JST, 8-pin, straight Head B: Flying leads Cable: Incremental, SSI, PUR, halogen-free, shielded, 10 m	DOL-0J08-G10MAA3	2046877
	Head A: female connector, JST, 8-pin, straight Head B: Flying leads Cable: SSI, Incremental, PUR, halogen-free, shielded, 1.5 m	DOL-0J08-G1M5AA6	2048590
	Head A: female connector, JST, 8-pin, straight Head B: Flying leads Cable: SSI, Incremental, PUR, halogen-free, shielded, 3 m	DOL-0J08-G3M0AA6	2048591

	Brief description	Type	Part no.
	Head A: female connector, JST, 8-pin, straight Head B: male connector, M23, 12-pin, straight Cable: Incremental, PUR, halogen-free, shielded, 1 m	STL-2312-G01MAA3	2061622
	Head A: female connector, JST, 8-pin, straight Head B: male connector, M23, 12-pin, straight Cable: Incremental, PUR, halogen-free, shielded, 2 m	STL-2312-G02MAA3	2061504
	Head A: female connector, JST, 8-pin, straight Head B: male connector, M23, 12-pin, straight Cable: Incremental, PUR, halogen-free, shielded, 0.35 m	STL-2312-GM35AA3	2061621
	Head A: male connector, M12, 8-pin, straight, A-coded Head B: - Cable: Incremental, shielded	STE-1208-GA01	6044892
	Head A: male connector, M23, 12-pin, straight Head B: - Cable: HIPERFACE <sup>®</sup> , SSI, Incremental, shielded	STE-2312-G01	2077273
		STE-2312-GX	6028548

## SICK AT A GLANCE

SICK is one of the leading manufacturers of intelligent sensors and sensor solutions for industrial applications. A unique range of products and services creates the perfect basis for controlling processes securely and efficiently, protecting individuals from accidents and preventing damage to the environment.

We have extensive experience in a wide range of industries and understand their processes and requirements. With intelligent sensors, we can deliver exactly what our customers need. In application centers in Europe, Asia and North America, system solutions are tested and optimized in accordance with customer specifications. All this makes us a reliable supplier and development partner.

Comprehensive services complete our offering: SICK LifeTime Services provide support throughout the machine life cycle and ensure safety and productivity.

For us, that is “Sensor Intelligence.”

## WORLDWIDE PRESENCE:

Contacts and other locations –[www.sick.com](http://www.sick.com)