



DBS60E-TDEJ01024

DBS60 Core

INCREMENTAL ENCODERS

SICK
Sensor Intelligence.



Illustration may differ



Ordering information

| Type | Part no. |
|------------------|----------|
| DBS60E-TDEJ01024 | 1080460 |

Other models and accessories → www.sick.com/DBS60_Core

Detailed technical data

Performance

| | |
|---------------------------------|--------------------------------------|
| Pulses per revolution | 1,024 |
| Measuring step | ≤ 90° electric/pulses per revolution |
| Measuring step deviation | ± 18° / pulses per revolution |
| Error limits | Measuring step deviation x 3 |
| Duty cycle | ≤ 0.5 ± 5 % |

Interfaces

| | |
|---------------------------------------|-------------------------|
| Communication interface | Incremental |
| Communication Interface detail | HTL / Push pull |
| Number of signal channels | 6-channel |
| Initialization time | < 5 ms ¹⁾ |
| Output frequency | + 300 kHz ²⁾ |
| Load current | ≤ 30 mA, per channel |
| Power consumption | ≤ 1 W (without load) |

¹⁾ Valid signals can be read once this time has elapsed.

²⁾ Up to 450 kHz on request.

Electrical data

| | |
|--|---|
| Connection type | Cable, 8-wire, universal, 0.5 m ¹⁾ |
| Supply voltage | 10 ... 27 V |
| Reference signal, number | 1 |
| Reference signal, position | 90°, electric, logically gated with A and B |
| Reverse polarity protection | ✓ |
| Short-circuit protection of the outputs | ✓ ²⁾ |
| MTTFd: mean time to dangerous failure | 500 years (EN ISO 13849-1) ³⁾ |

¹⁾ The universal cable connection is positioned so that it is possible to lay it without bends in a radial or axial direction.

²⁾ Short-circuit opposite to another channel, US or GND permissible for maximum 30 s.

³⁾ This product is a standard product and does not constitute a safety component as defined in the Machinery Directive. Calculation based on nominal load of components, average ambient temperature 40°C, frequency of use 8760 h/a. All electronic failures are considered hazardous. For more information, see document no. 8015532.

Mechanical data

| | |
|--|---|
| Mechanical design | Through hollow shaft, Front clamp |
| Shaft diameter | 10 mm |
| Flange type / stator coupling | 2-sided stator coupling, slot, screw hole circle 63–83 mm |
| Weight | + 0.25 kg ¹⁾ |
| Shaft material | Stainless steel |
| Flange material | Aluminum |
| Housing material | Aluminum |
| Material, cable | PVC |
| Start up torque | + 0.5 Ncm (+20 °C) |
| Operating torque | 0.4 Ncm (+20 °C) |
| Permissible shaft movement, axial static/dynamic | ± 0.5 mm / ± 0.2 mm ²⁾ |
| Permissible shaft movement, radial static/dynamic | ± 0.3 mm / ± 0.1 mm ²⁾ |
| Operating speed | 6,000 min ⁻¹ ³⁾ |
| Maximum operating speed | 9,000 min ⁻¹ ⁴⁾ |
| Moment of inertia of the rotor | 50 gcm ² |
| Bearing lifetime | 3.6 x 10 ⁹ revolutions |
| Angular acceleration | ≤ 500,000 rad/s ² |

¹⁾ Based on an encoder with a male connector outlet or a cable with a male connector outlet.

²⁾ Not applicable for stator coupling type C and K.

³⁾ Allow for self-heating of 2.6 K per 1,000 rpm when designing the operating temperature range.

⁴⁾ Maximum speed which does not cause mechanical damage to the encoder. Impact on the service life and signal quality is possible. Please note the maximum output frequency.

Ambient data

| | |
|--------------------------------------|--|
| EMC | According to EN 61000-6-2 and EN 61000-6-3 |
| Enclosure rating | IP65, housing side (according to IEC 60529) IP65, shaft side (according to IEC 60529) |
| Permissible relative humidity | 90 % (condensation of the optical scanning not permitted) |
| Operating temperature range | -20 °C ... +85 °C ¹⁾ |
| Storage temperature range | -40 °C ... +100 °C, without package |
| Resistance to shocks | 250 g, 3 ms (according to EN 60068-2-27) |
| Resistance to vibration | 30 g, 10 Hz ... 2,000 Hz (according to EN 60068-2-6) |

¹⁾ These values relate to all mechanical versions including recommended accessories unless otherwise noted.

Classifications

| | |
|---------------------|----------|
| ECl@ss 5.0 | 27270501 |
| ECl@ss 5.1.4 | 27270501 |
| ECl@ss 6.0 | 27270590 |
| ECl@ss 6.2 | 27270590 |
| ECl@ss 7.0 | 27270501 |
| ECl@ss 8.0 | 27270501 |

| | |
|-----------------------|----------|
| ECl@ss 8.1 | 27270501 |
| ECl@ss 9.0 | 27270501 |
| ECl@ss 10.0 | 27270501 |
| ECl@ss 11.0 | 27270501 |
| ETIM 5.0 | EC001486 |
| ETIM 6.0 | EC001486 |
| ETIM 7.0 | EC001486 |
| UNSPSC 16.0901 | 41112113 |

Dimensional drawing (Dimensions in mm (inch))

Through hollow shaft clamping at the front, cable connection, 2-sided stator coupling, slot, screw hole circle 63–83 mm

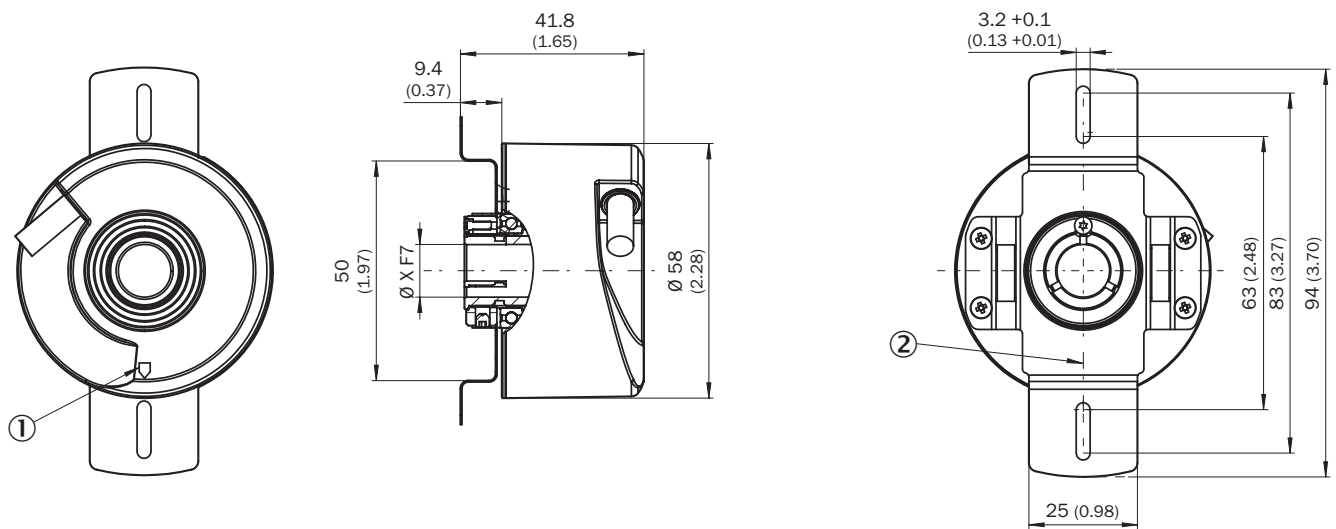

XF7 values see shaft diameter table for through hollow shaft, clamping at the front

- ① Zero pulse mark on housing
- ② Zero pulse mark on flange under stator coupling

| Type Through hollow shaft with front clamping | Shaft diameter XF7 |
|--|--------------------|
| DBS60x-TAxxxxxxx DBS60x-T1xxxxxxx | 6 mm |
| DBS60x-TBxxxxxxx DBS60x-T2xxxxxxx | 8 mm |
| DBS60x-TCxxxxxxx DBS60x-T3xxxxxxx | 3/8" |
| DBS60x-TDxxxxxxx DBS60x-T4xxxxxxx | 10 mm |
| DBS60x-TExxxxxxx DBS60x-T5xxxxxxx | 12 mm |
| DBS60x-TFxxxxxxx DBS60x-T6xxxxxxx | 1/2" |
| DBS60x-TGxxxxxxx DBS60x-T7xxxxxxx | 14 mm |
| DBS60x-THxxxxxxx DBS60x-T8xxxxxxx | 15 mm |

| Type | Shaft diameter XF7 |
|--|--------------------|
| Through hollow shaft with front clamping | |
| DBS60x-TJxxxxxxx | 5/8" |

Attachment specifications

Through hollow shaft with front clamping

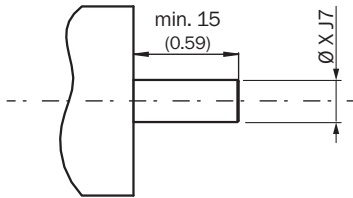

Customer side

| Type | Shaft diameter xj7 |
|--|--------------------|
| Through hollow shaft with front clamping | |
| DBS60x-TAxxxxxxx DBS60x-T1xxxxxxx | 6 mm |
| DBS60x-TBxxxxxxx DBS60x-T2xxxxxxx | 8 mm |
| DBS60x-TCxxxxxxx DBS60x-T3xxxxxxx | 3/8" |
| DBS60x-TDxxxxxxx DBS60x-T4xxxxxxx | 10 mm |
| DBS60x-TExxxxxxx DBS60x-T5xxxxxxx | 12 mm |
| DBS60x-TFxxxxxxx DBS60x-T6xxxxxxx | 1/2" |
| DBS60x-TGxxxxxxx DBS60x-T7xxxxxxx | 14 mm |
| DBS60x-THxxxxxxx DBS60x-T8xxxxxxx | 15 mm |
| DBS60x-TJxxxxxxx | 5/8" |

PIN assignment

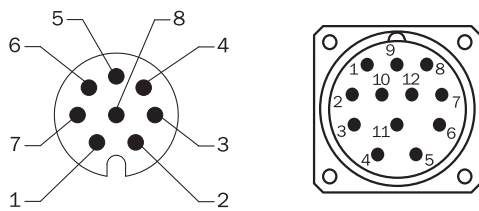

View of M12 / M23 male device connector on cable / housing

| Wire colors (cable connection) | Male connector M12, 8-pin | Male connector M23, 12-pin | TTL/HTL 6-channel signal | Explanation |
|--------------------------------|---------------------------|----------------------------|--------------------------|-------------|
| Brown | 1 | 6 | A- | Signal wire |

| Wire colors (cable connection) | Male connector M12, 8-pin | Male connector M23, 12-pin | TTL/HTL 6-channel signal | Explanation |
|--------------------------------|---------------------------|----------------------------|--------------------------|-------------------------------------|
| White | 2 | 5 | A | Signal wire |
| Black | 3 | 1 | B- | Signal wire |
| Pink | 4 | 8 | B | Signal wire |
| Yellow | 5 | 4 | Z- | Signal wire |
| Purple | 6 | 3 | Z | Signal wire |
| Blue | 7 | 10 | GND | Ground connection |
| Red | 8 | 12 | +U _s | Supply voltage |
| - | - | 9 | Not assigned | Not assigned |
| - | - | 2 | Not assigned | Not assigned |
| - | - | 11 | Not assigned | Not assigned |
| - | - | 7 | Not assigned | Not assigned |
| Screen | Screen | Screen | Screen | Screen connected to encoder housing |

Maximum revolution range

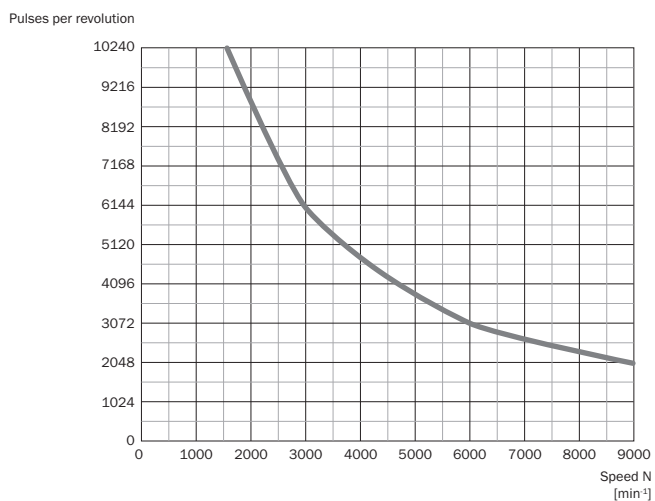

Signal outputs

Signal outputs for electrical interfaces TTL and HTL





Cw with view on the encoder shaft in direction "A", compare dimensional drawing.

| Supply voltage | Output |
|-----------------|-------------------|
| 4,5 V ... 5,5 V | TTL |
| 10 V ... 30 V | TTL |
| 10 V ... 27 V | HTL |
| 4,5 V ... 30 V | TTL/HTL universal |
| 4,5 V ... 30 V | TTL |

Recommended accessories

Other models and accessories → www.sick.com/DBS60_Core

| | Brief description | Type | Part no. |
|----------------------------|--|----------------|----------|
| Plug connectors and cables | | | |
| | Head A: cable Head B: Flying leads Cable: SSI, Incremental, HIPERFACE [®] , PUR, halogen-free, shielded | LTG-2308-MWENC | 6027529 |
| | Head A: cable Head B: Flying leads Cable: SSI, Incremental, PUR, shielded | LTG-2411-MW | 6027530 |
| | Head A: cable Head B: Flying leads Cable: SSI, Incremental, PUR, halogen-free, shielded | LTG-2512-MW | 6027531 |
| | Head A: cable Head B: Flying leads Cable: SSI, TTL, HTL, Incremental, PUR, halogen-free, shielded | LTG-2612-MW | 6028516 |

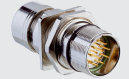
| | Brief description | Type | Part no. |
|---|--|---------------|----------|
|  | Head A: male connector, M12, 8-pin, straight, A-coded Head B: - Cable: Incremental, shielded | STE-1208-GA01 | 6044892 |
|  | Head A: male connector, M23, 12-pin, straight Head B: - Cable: HIPERFACE [®] , SSI, Incremental, shielded | STE-2312-G01 | 2077273 |
|  | | STE-2312-GX | 6028548 |

SICK AT A GLANCE

SICK is one of the leading manufacturers of intelligent sensors and sensor solutions for industrial applications. A unique range of products and services creates the perfect basis for controlling processes securely and efficiently, protecting individuals from accidents and preventing damage to the environment.

We have extensive experience in a wide range of industries and understand their processes and requirements. With intelligent sensors, we can deliver exactly what our customers need. In application centers in Europe, Asia and North America, system solutions are tested and optimized in accordance with customer specifications. All this makes us a reliable supplier and development partner.

Comprehensive services complete our offering: SICK LifeTime Services provide support throughout the machine life cycle and ensure safety and productivity.

For us, that is “Sensor Intelligence.”

WORLDWIDE PRESENCE:

Contacts and other locations –www.sick.com