



DBS60E-S1AK03600

DBS60 Core

INCREMENTAL ENCODERS

SICK
Sensor Intelligence.



Illustration may differ



Ordering information

| Type | Part no. |
|------------------|----------|
| DBS60E-S1AK03600 | 1081331 |

Other models and accessories → www.sick.com/DBS60_Core

Detailed technical data

Performance

| | |
|---------------------------------|--------------------------------------|
| Pulses per revolution | 3,600 |
| Measuring step | ≤ 90° electric/pulses per revolution |
| Measuring step deviation | ± 36° / pulses per revolution |
| Error limits | Measuring step deviation x 3 |
| Duty cycle | ≤ 0.5 ± 10 % |

Interfaces

| | |
|---------------------------------------|-------------------------|
| Communication interface | Incremental |
| Communication Interface detail | TTL / RS-422 |
| Number of signal channels | 6-channel |
| Initialization time | < 5 ms ¹⁾ |
| Output frequency | + 300 kHz ²⁾ |
| Load current | ≤ 30 mA, per channel |
| Operating current | ≤ 50 mA (without load) |

¹⁾ Valid signals can be read once this time has elapsed.

²⁾ Up to 450 kHz on request.

Electrical data

| | |
|--|---|
| Connection type | Cable, 8-wire, universal, 1.5 m ¹⁾ |
| Supply voltage | 4.5 ... 5.5 V |
| Reference signal, number | 1 |
| Reference signal, position | 90°, electric, logically gated with A and B |
| Reverse polarity protection | ✓ |
| Short-circuit protection of the outputs | ✓ ²⁾ |
| MTTFd: mean time to dangerous failure | 500 years (EN ISO 13849-1) ³⁾ |

¹⁾ The universal cable connection is positioned so that it is possible to lay it without bends in a radial or axial direction.

²⁾ Short-circuit opposite to another channel or GND permissible for max. 60 s. No protection signal against U_S.

³⁾ This product is a standard product and does not constitute a safety component as defined in the Machinery Directive. Calculation based on nominal load of components, average ambient temperature 40°C, frequency of use 8760 h/a. All electronic failures are considered hazardous. For more information, see document no. 8015532.

Mechanical data

| | |
|---|--|
| Mechanical design | Solid shaft, Servo flange |
| Shaft diameter | 6 mm ¹⁾ |
| Shaft length | 10 mm |
| Flange type / stator coupling | Flange with 3 x M3 and 3 x M4 |
| Weight | + 0.3 kg ²⁾ |
| Shaft material | Stainless steel |
| Flange material | Aluminum |
| Housing material | Aluminum |
| Material, cable | PVC |
| Start up torque | + 1.2 Ncm (+20 °C) |
| Operating torque | 1.1 Ncm (+20 °C) |
| Permissible shaft loading radial/axial | 100 N (radial) ³⁾ 50 N (axial) ³⁾ |
| Operating speed | 6,000 min ⁻¹ ⁴⁾ |
| Maximum operating speed | 9,000 min ⁻¹ ⁵⁾ |
| Moment of inertia of the rotor | 33 gcm ² |
| Bearing lifetime | 3.6 x 10 ⁹ revolutions |
| Angular acceleration | ≤ 500,000 rad/s ² |

¹⁾ Others on request.

²⁾ Based on an encoder with a male connector outlet or a cable with a male connector outlet.

³⁾ Higher values are possible using limited bearing life.

⁴⁾ Allow for self-heating of 3.2 K per 1,000 rpm when designing the operating temperature range.

⁵⁾ Maximum speed which does not cause mechanical damage to the encoder. Impact on the service life and signal quality is possible. Please note the maximum output frequency.

Ambient data

| | |
|--------------------------------------|--|
| EMC | According to EN 61000-6-2 and EN 61000-6-3 |
| Enclosure rating | IP67, housing side (according to IEC 60529) IP65, shaft side (according to IEC 60529) |
| Permissible relative humidity | 90 % (condensation of the optical scanning not permitted) |
| Operating temperature range | -20 °C ... +85 °C ¹⁾ |
| Storage temperature range | -40 °C ... +100 °C, without package |
| Resistance to shocks | 250 g, 3 ms (according to EN 60068-2-27) |
| Resistance to vibration | 30 g, 10 Hz ... 2,000 Hz (according to EN 60068-2-6) |

¹⁾ These values relate to all mechanical versions including recommended accessories unless otherwise noted.

Classifications

| | |
|---------------------|----------|
| ECl@ss 5.0 | 27270501 |
| ECl@ss 5.1.4 | 27270501 |
| ECl@ss 6.0 | 27270590 |
| ECl@ss 6.2 | 27270590 |
| ECl@ss 7.0 | 27270501 |
| ECl@ss 8.0 | 27270501 |

| | |
|-----------------------|----------|
| ECl@ss 8.1 | 27270501 |
| ECl@ss 9.0 | 27270501 |
| ECl@ss 10.0 | 27270501 |
| ECl@ss 11.0 | 27270501 |
| ETIM 5.0 | EC001486 |
| ETIM 6.0 | EC001486 |
| ETIM 7.0 | EC001486 |
| UNSPSC 16.0901 | 41112113 |

Dimensional drawing (Dimensions in mm (inch))

Solid shaft \varnothing 6 mm, servo flange, cable connection

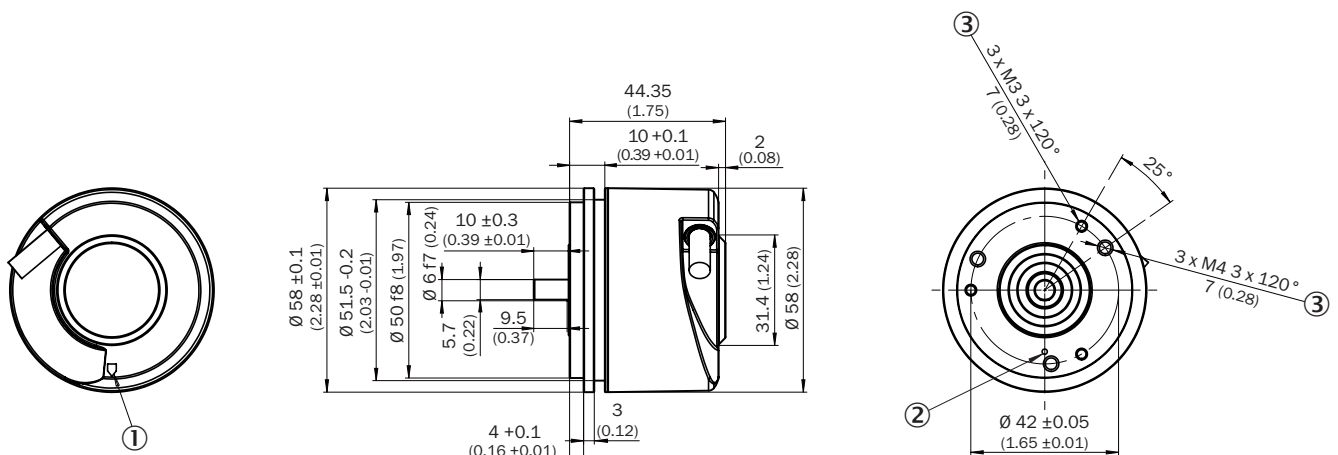

- ① Zero pulse mark on housing
- ② Zero pulse mark on flange
- ③ Depth

Attachment specifications

Mounting requirements for half-shell servo clamp

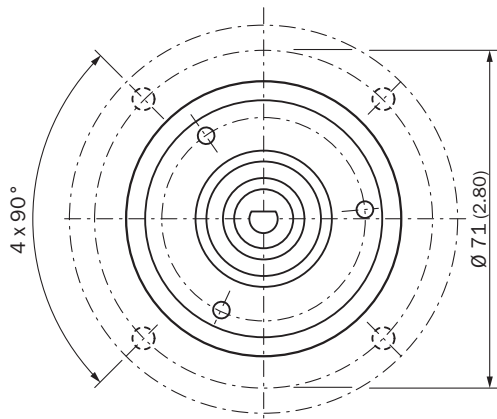

All dimensions in mm (inch)

Mounting requirements for small servo clamp

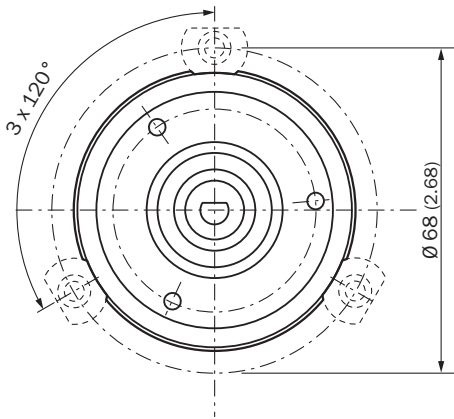

All dimensions in mm (inch)

PIN assignment

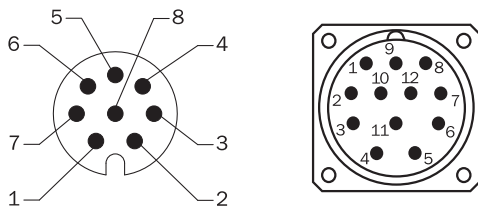

View of M12 / M23 male device connector on cable / housing

| Wire colors (cable connection) | Male connector M12, 8-pin | Male connector M23, 12-pin | TTL/HTL 6-channel signal | Explanation |
|--------------------------------|---------------------------|----------------------------|--------------------------|-------------------------------------|
| Brown | 1 | 6 | A- | Signal wire |
| White | 2 | 5 | A | Signal wire |
| Black | 3 | 1 | B- | Signal wire |
| Pink | 4 | 8 | B | Signal wire |
| Yellow | 5 | 4 | Z- | Signal wire |
| Purple | 6 | 3 | Z | Signal wire |
| Blue | 7 | 10 | GND | Ground connection |
| Red | 8 | 12 | +U _s | Supply voltage |
| - | - | 9 | Not assigned | Not assigned |
| - | - | 2 | Not assigned | Not assigned |
| - | - | 11 | Not assigned | Not assigned |
| - | - | 7 | Not assigned | Not assigned |
| Screen | Screen | Screen | Screen | Screen connected to encoder housing |

Maximum revolution range

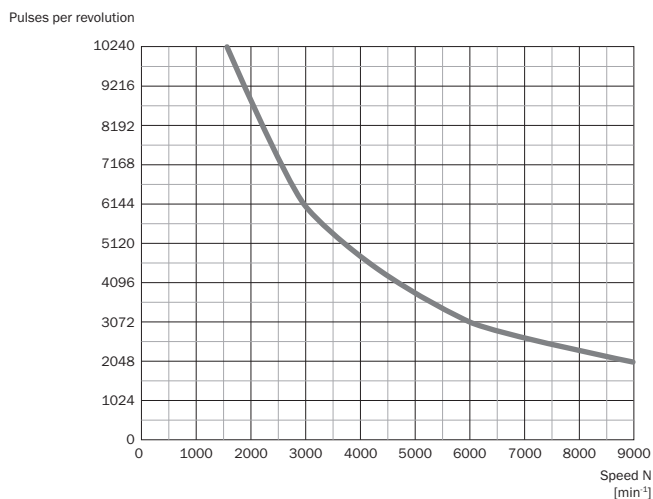

Signal outputs

Signal outputs for electrical interfaces TTL and HTL

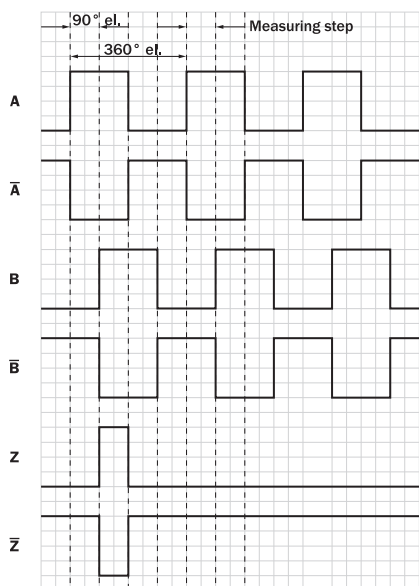





















Cw with view on the encoder shaft in direction "A", compare dimensional drawing.

| Supply voltage | Output |
|-----------------|-------------------|
| 4,5 V ... 5,5 V | TTL |
| 10 V ... 30 V | TTL |
| 10 V ... 27 V | HTL |
| 4,5 V ... 30 V | TTL/HTL universal |
| 4,5 V ... 30 V | TTL |

Recommended accessories

Other models and accessories → www.sick.com/DBS60_Core

| | Brief description | Type | Part no. |
|---|--|----------------|----------|
| Other mounting accessories | | | |
|  | Aluminium measuring wheel with O-ring (NBR70) for 6 mm solid shaft, circumference 200 mm | BEF-MR006020R | 2055222 |
| | Measuring wheel with O-ring (NBR70) for 6 mm solid shaft, circumference 300 mm | BEF-MR006030R | 2055634 |
| | Aluminium measuring wheel with O-ring (NBR70) for 6 mm solid shaft, circumference 500 mm | BEF-MR006050R | 2055225 |
|  | Aluminum measuring wheel with cross-knurled surface for 6 mm solid shaft, circumference 200 mm | BEF-MR06200AK | 4084745 |
|  | Aluminum measuring wheel with smooth polyurethane surface for 6 mm solid shaft, circumference 200 mm | BEF-MR06200AP | 4084746 |
|  | Aluminum measuring wheel with ridged polyurethane surface for 6 mm solid shaft, circumference 200 mm | BEF-MR06200APG | 4084748 |
|  | Aluminum measuring wheel with studded polyurethane surface for 6 mm solid shaft, circumference 200 mm | BEF-MR06200APN | 4084747 |
| | O-ring for measuring wheels (circumference 200 mm) | BEF-OR-053-040 | 2064061 |
| | O-ring for measuring wheels (circumference 300 mm) | BEF-OR-083-050 | 2064076 |
| | O-ring for measuring wheels (circumference 500 mm) | BEF-OR-145-050 | 2064074 |
|  | Mounting bell for encoder with servo flange, 50 mm spigot, mounting kit included | BEF-MG-50 | 5312987 |
|  | Bearing block for servo and face mount flange encoder. The heavy-duty bearing block is used to absorb very large radial and axial shaft loads. Particularly when using belt pulleys, chain sprockets, friction wheels. Operating speed max. 4,000 rpm ⁻¹ , axial shaft load 150 N, radial shaft load 250 N, bearing service life 3.6 x 10 ⁹ revolutions | BEF-FA-LB1210 | 2044591 |
| | Mounting kit for servo flange encoder on the bearing block, 1 bar coupling SKPS 1520 06/06 1 hexagon socket wrench SW1.5 DIN 911, 3 mounting eccentric BEMN 1242 49 3 screws M4 x 10 DIN 912, 1 hexagon socket wrench SW3 DIN 911, 1 bar coupling SKPS 1520 06/06 1 hexagon socket wrench SW1.5 DIN 911, 3 mounting eccentric BEMN 1242 49 3 screws M4 x 10 DIN 912, 1 hexagon socket wrench SW3 DIN 911 | BEF-MK-LB | 5320872 |
|  | Half-shell servo clamps (2 pcs.) for servo flanges with a 50 mm centering hub | BEF-WG-SF050 | 2029165 |
|  | Servo clamps, large, for servo flanges (clamps, eccentric fastener), 3 pcs., without mounting material, without mounting hardware | BEF-WK-SF | 2029166 |
| Shaft adaptation | | | |
|  | Bellows coupling, shaft diameter 6 mm / 6 mm, maximum shaft offset: radial ± 0.25 mm, axial ± 0.4 mm, angular +/- 4°; max. speed 10,000 rpm, -30 °C to +120 °C, max. torque 80 Ncm; material: stainless steel bellows, aluminum hub | KUP-0606-B | 5312981 |
|  | Bar coupling, shaft diameter 6 mm / 6 mm, maximum shaft offset: radial ± 0.3 mm, axial ± 0.2 mm, angle ± 3°; max. speed 10,000 rpm, -10° to +80 °C, max. torque 80 Ncm; material: fiber-glass reinforced polyamide, aluminum hub | KUP-0606-S | 2056406 |
| | Bar coupling, shaft diameter 6 mm / 8 mm, maximum shaft offset radial ± 0.3 mm, axial ± 0.2 mm, angle ± 3°, max. speed 10,000 rpm, torsion spring rigidity 38 Nm/wheel; material: fiber-glass reinforced polyamide, aluminum hub | KUP-0608-S | 5314179 |

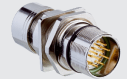
| | Brief description | Type | Part no. |
|---|--|----------------|----------|
|  | Bellows coupling, shaft diameter 6 mm / 10 mm, maximum shaft offset: radial ± 0.25 mm, axial ± 0.4 mm, angular $\pm 4^\circ$; max. speed 10,000 rpm, -30°C to $+120^\circ\text{C}$, max. torque 80 Ncm; material: stainless steel bellows, aluminum hub | KUP-0610-B | 5312982 |
|  | Double loop coupling, shaft diameter 6 mm / 10 mm, max. shaft offset: radially ± 2.5 mm, axially ± 3 mm, angle ± 10 degrees; max. speed 3,000 rpm, -30 to $+80$ degrees Celsius, torsional spring stiffness of 25 Nm/rad | KUP-0610-D | 5326697 |
|  | Spring washer coupling, shaft diameter 6 mm / 10 mm, Maximum shaft offset: radial ± 0.3 mm, axial ± 0.4 mm, angular $\pm 2.5^\circ$; max. speed 12,000 rpm, -10° to $+80^\circ\text{C}$, max. torque 60 Ncm; material: aluminum flange, glass fiber-reinforced polyamide membrane and hardened steel coupling pin | KUP-0610-F | 5312985 |
|  | Bar coupling, shaft diameter 6 mm / 10 mm, max. shaft offset: radial ± 0.3 mm, axial ± 0.3 mm, angular $\pm 3^\circ$; max. speed 10,000 rpm, -10° to $+80^\circ\text{C}$, max. torque: 80 Ncm, material: fiber-glass reinforced polyamide, aluminum hub | KUP-0610-S | 2056407 |
| Plug connectors and cables | | | |
|  | Head A: cable Head B: Flying leads Cable: SSI, Incremental, HIPERFACE [®] , PUR, halogen-free, shielded | LTG-2308-MWENC | 6027529 |
|  | Head A: cable Head B: Flying leads Cable: SSI, Incremental, PUR, shielded | LTG-2411-MW | 6027530 |
|  | Head A: cable Head B: Flying leads Cable: SSI, Incremental, PUR, halogen-free, shielded | LTG-2512-MW | 6027531 |
|  | Head A: cable Head B: Flying leads Cable: SSI, TTL, HTL, Incremental, PUR, halogen-free, shielded | LTG-2612-MW | 6028516 |
|  | Head A: male connector, M12, 8-pin, straight, A-coded Head B: - Cable: Incremental, shielded | STE-1208-GA01 | 6044892 |
|  | Head A: male connector, M23, 12-pin, straight Head B: - Cable: HIPERFACE [®] , SSI, Incremental, shielded | STE-2312-G01 | 2077273 |
|  | | STE-2312-GX | 6028548 |

SICK AT A GLANCE

SICK is one of the leading manufacturers of intelligent sensors and sensor solutions for industrial applications. A unique range of products and services creates the perfect basis for controlling processes securely and efficiently, protecting individuals from accidents and preventing damage to the environment.

We have extensive experience in a wide range of industries and understand their processes and requirements. With intelligent sensors, we can deliver exactly what our customers need. In application centers in Europe, Asia and North America, system solutions are tested and optimized in accordance with customer specifications. All this makes us a reliable supplier and development partner.

Comprehensive services complete our offering: SICK LifeTime Services provide support throughout the machine life cycle and ensure safety and productivity.

For us, that is “Sensor Intelligence.”

WORLDWIDE PRESENCE:

Contacts and other locations –www.sick.com