

# DBS60E-TEEJE0100

DBS60 Core

INCREMENTAL ENCODERS

**SICK**  
Sensor Intelligence.

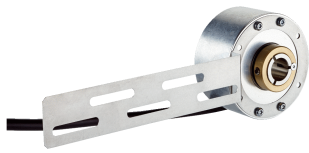

Illustration may differ

### Ordering information

Type	Part no.
DBS60E-TEEJE0100	1083654

Other models and accessories → [www.sick.com/DBS60\\_Core](http://www.sick.com/DBS60_Core)



### Detailed technical data

#### Performance

<b>Pulses per revolution</b>	100
<b>Measuring step</b>	≤ 90° electric/pulses per revolution
<b>Measuring step deviation</b>	± 18° / pulses per revolution
<b>Error limits</b>	Measuring step deviation x 3
<b>Duty cycle</b>	≤ 0.5 ± 5 %

#### Interfaces

<b>Communication interface</b>	Incremental
<b>Communication Interface detail</b>	HTL / Push pull
<b>Number of signal channels</b>	6-channel
<b>Initialization time</b>	< 5 ms <sup>1)</sup>
<b>Output frequency</b>	+ 300 kHz <sup>2)</sup>
<b>Load current</b>	≤ 30 mA, per channel
<b>Power consumption</b>	≤ 1 W (without load)

<sup>1)</sup> Valid signals can be read once this time has elapsed.

<sup>2)</sup> Up to 450 kHz on request.

#### Electrical data

<b>Connection type</b>	Cable, 8-wire, universal, 0.5 m <sup>1)</sup>
<b>Supply voltage</b>	10 ... 27 V
<b>Reference signal, number</b>	1
<b>Reference signal, position</b>	90°, electric, logically gated with A and B
<b>Reverse polarity protection</b>	✓
<b>Short-circuit protection of the outputs</b>	✓ <sup>2)</sup>
<b>MTTFd: mean time to dangerous failure</b>	500 years (EN ISO 13849-1) <sup>3)</sup>

<sup>1)</sup> The universal cable connection is positioned so that it is possible to lay it without bends in a radial or axial direction.

<sup>2)</sup> Short-circuit opposite to another channel, US or GND permissible for maximum 30 s.

<sup>3)</sup> This product is a standard product and does not constitute a safety component as defined in the Machinery Directive. Calculation based on nominal load of components, average ambient temperature 40 °C, frequency of use 8760 h/a. All electronic failures are considered hazardous. For more information, see document no. 8015532.

## Mechanical data

<b>Mechanical design</b>	Through hollow shaft, Front clamp
<b>Shaft diameter</b>	12 mm
<b>Flange type / stator coupling</b>	One-sided stator coupling, slots, slot radius 32.25–142.55 mm, slot width 4.5 mm
<b>Weight</b>	+ 0.25 kg <sup>1)</sup>
<b>Shaft material</b>	Stainless steel
<b>Flange material</b>	Aluminum
<b>Housing material</b>	Aluminum
<b>Material, cable</b>	PVC
<b>Start up torque</b>	+ 0.5 Ncm (+20 °C)
<b>Operating torque</b>	0.4 Ncm (+20 °C)
<b>Permissible shaft movement, axial static/dynamic</b>	± 0.5 mm / ± 0.2 mm <sup>2)</sup>
<b>Permissible shaft movement, radial static/dynamic</b>	± 0.3 mm / ± 0.1 mm <sup>2)</sup>
<b>Operating speed</b>	6,000 min <sup>-1</sup> <sup>3)</sup>
<b>Maximum operating speed</b>	9,000 min <sup>-1</sup> <sup>4)</sup>
<b>Moment of inertia of the rotor</b>	50 gcm <sup>2</sup>
<b>Bearing lifetime</b>	3.6 x 10 <sup>9</sup> revolutions
<b>Angular acceleration</b>	≤ 500,000 rad/s <sup>2</sup>

<sup>1)</sup> Based on an encoder with a male connector outlet or a cable with a male connector outlet.

<sup>2)</sup> Not applicable for stator coupling type C and K.

<sup>3)</sup> Allow for self-heating of 2.6 K per 1,000 rpm when designing the operating temperature range.

<sup>4)</sup> Maximum speed which does not cause mechanical damage to the encoder. Impact on the service life and signal quality is possible. Please note the maximum output frequency.

## Ambient data

<b>EMC</b>	According to EN 61000-6-2 and EN 61000-6-3
<b>Enclosure rating</b>	IP65, housing side (according to IEC 60529) IP65, shaft side (according to IEC 60529)
<b>Permissible relative humidity</b>	90 % (condensation of the optical scanning not permitted)
<b>Operating temperature range</b>	-20 °C ... +85 °C <sup>1)</sup>
<b>Storage temperature range</b>	-40 °C ... +100 °C, without package
<b>Resistance to shocks</b>	250 g, 3 ms (according to EN 60068-2-27)
<b>Resistance to vibration</b>	30 g, 10 Hz ... 2,000 Hz (according to EN 60068-2-6)

<sup>1)</sup> These values relate to all mechanical versions including recommended accessories unless otherwise noted.

## Classifications

<b>ECl@ss 5.0</b>	27270501
<b>ECl@ss 5.1.4</b>	27270501
<b>ECl@ss 6.0</b>	27270590
<b>ECl@ss 6.2</b>	27270590
<b>ECl@ss 7.0</b>	27270501
<b>ECl@ss 8.0</b>	27270501

<b>ECl@ss 8.1</b>	27270501
<b>ECl@ss 9.0</b>	27270501
<b>ECl@ss 10.0</b>	27270501
<b>ECl@ss 11.0</b>	27270501
<b>ETIM 5.0</b>	EC001486
<b>ETIM 6.0</b>	EC001486
<b>ETIM 7.0</b>	EC001486
<b>UNSPSC 16.0901</b>	41112113

**Dimensional drawing** (Dimensions in mm (inch))

Through hollow shaft clamping at the front, cable connection, 1-sided stator coupling, slots, screw hole circle radius 32.25–142.75 mm

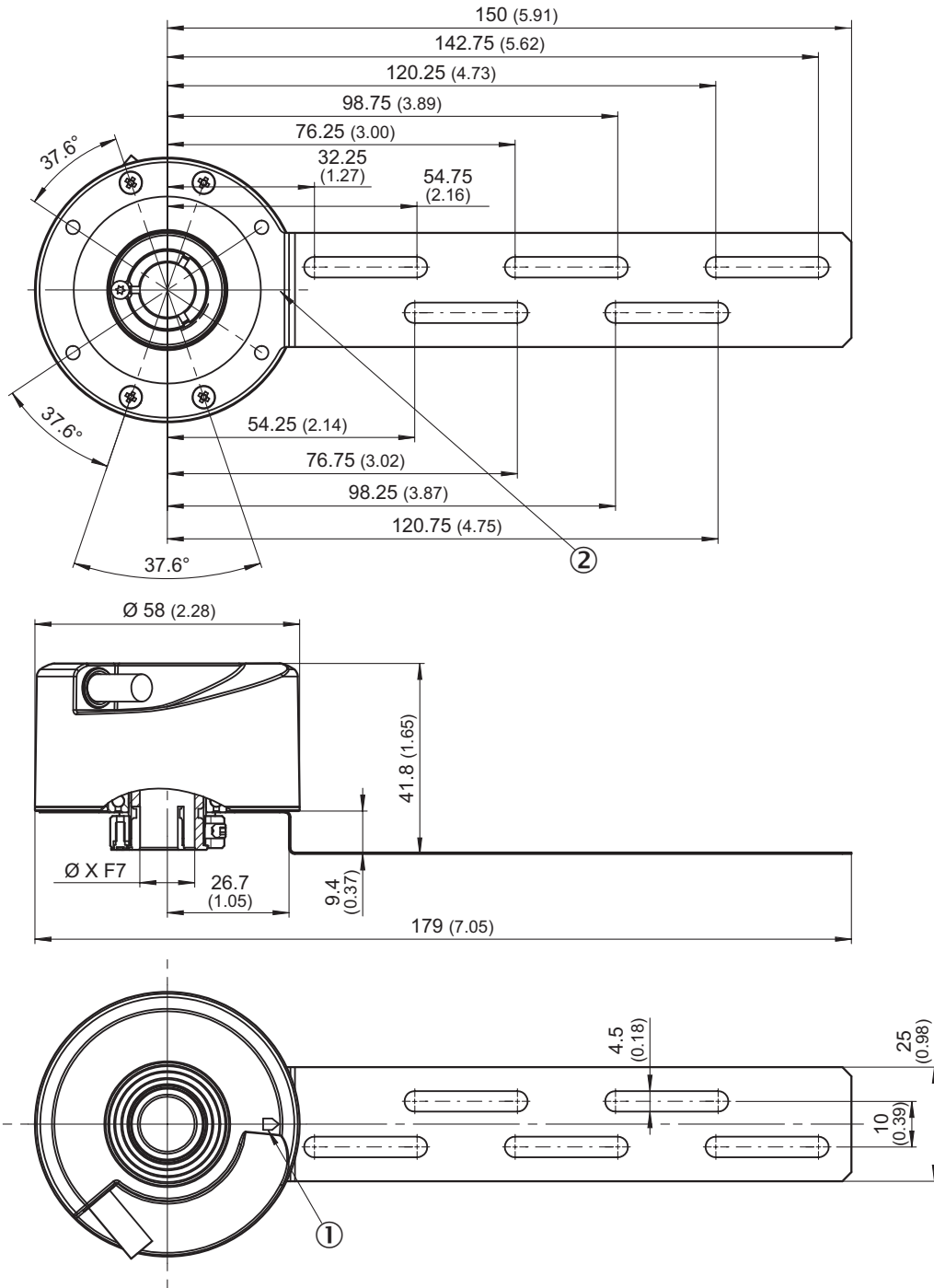

XF7 values see shaft diameter table for through hollow shaft, clamping at the front

- ① Zero pulse mark on housing
- ② Zero pulse mark on flange under stator coupling

Type Through hollow shaft with front clamping	Shaft diameter XF7
DBS60x-TAxxxxxxx DBS60x-T1xxxxxxx	6 mm

Type Through hollow shaft with front clamping	Shaft diameter XF7
DBS60x-TBxxxxxxx DBS60x-T2xxxxxxx	8 mm
DBS60x-TCxxxxxxx DBS60x-T3xxxxxxx	3/8"
DBS60x-TDxxxxxxx DBS60x-T4xxxxxxx	10 mm
DBS60x-TExxxxxxx DBS60x-T5xxxxxxx	12 mm
DBS60x-TFxxxxxxx DBS60x-T6xxxxxxx	1/2"
DBS60x-TGxxxxxxx DBS60x-T7xxxxxxx	14 mm
DBS60x-THxxxxxxx DBS60x-T8xxxxxxx	15 mm
DBS60x-TJxxxxxxx	5/8"

### Attachment specifications

Through hollow shaft with front clamping

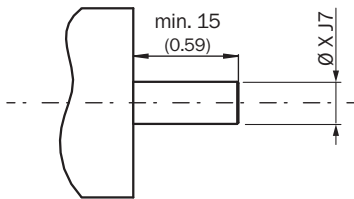

Customer side

Type Through hollow shaft with front clamping	Shaft diameter xj7
DBS60x-TAxxxxxxx DBS60x-T1xxxxxxx	6 mm
DBS60x-TBxxxxxxx DBS60x-T2xxxxxxx	8 mm
DBS60x-TCxxxxxxx DBS60x-T3xxxxxxx	3/8"
DBS60x-TDxxxxxxx DBS60x-T4xxxxxxx	10 mm
DBS60x-TExxxxxxx DBS60x-T5xxxxxxx	12 mm
DBS60x-TFxxxxxxx DBS60x-T6xxxxxxx	1/2"
DBS60x-TGxxxxxxx DBS60x-T7xxxxxxx	14 mm
DBS60x-THxxxxxxx DBS60x-T8xxxxxxx	15 mm
DBS60x-TJxxxxxxx	5/8"

### PIN assignment

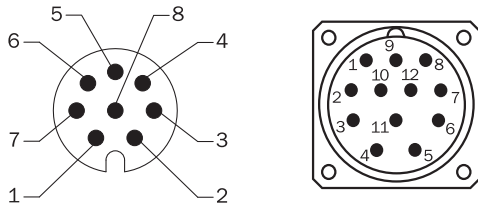

View of M12 / M23 male device connector on cable / housing

Wire colors (cable connection)	Male connector M12, 8-pin	Male connector M23, 12-pin	TTL/HTL 6-channel signal	Explanation
Brown	1	6	A-	Signal wire
White	2	5	A	Signal wire
Black	3	1	B-	Signal wire
Pink	4	8	B	Signal wire
Yellow	5	4	Z-	Signal wire
Purple	6	3	Z	Signal wire
Blue	7	10	GND	Ground connection
Red	8	12	+U <sub>s</sub>	Supply voltage
-	-	9	Not assigned	Not assigned
-	-	2	Not assigned	Not assigned
-	-	11	Not assigned	Not assigned
-	-	7	Not assigned	Not assigned
Screen	Screen	Screen	Screen	Screen connected to encoder housing

### Maximum revolution range

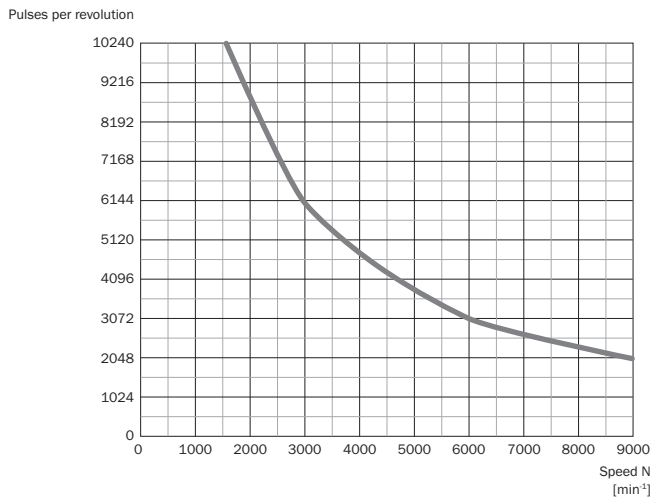

### Signal outputs

Signal outputs for electrical interfaces TTL and HTL

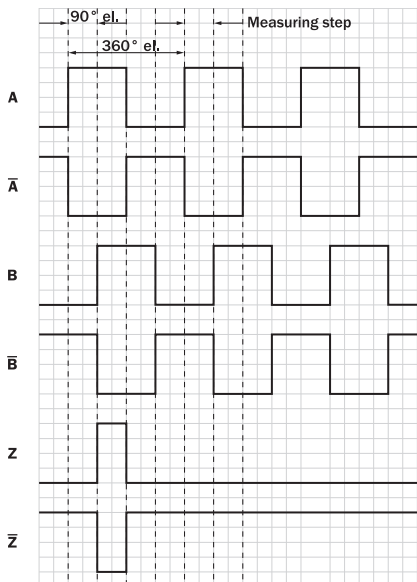









Cw with view on the encoder shaft in direction "A", compare dimensional drawing.

Supply voltage	Output
4,5 V ... 5,5 V	TTL
10 V ... 30 V	TTL
10 V ... 27 V	HTL
4,5 V ... 30 V	TTL/HTL universal
4,5 V ... 30 V	TTL

### Recommended accessories

Other models and accessories → [www.sick.com/DBS60\\_Core](http://www.sick.com/DBS60_Core)

	Brief description	Type	Part no.
<b>Other mounting accessories</b>			
	Bearing bracket for hollow shaft encoders, fastening screws included the Bearing Block is intended for very large radial and axial shaft loads. Particularly for application on: Belt pulleys, Chain pinions, Friction wheels. It is designed this way to enable fitting of encoder with blind hollow shaft with $\varnothing$ 12 mm., fastening screws included	BEF-FA-B12-010	2042728
<b>Plug connectors and cables</b>			
	Head A: cable Head B: Flying leads Cable: SSI, Incremental, HIPERFACE®, PUR, halogen-free, shielded	LTG-2308-MWENC	6027529
	Head A: cable Head B: Flying leads Cable: SSI, Incremental, PUR, shielded	LTG-2411-MW	6027530
	Head A: cable Head B: Flying leads Cable: SSI, Incremental, PUR, halogen-free, shielded	LTG-2512-MW	6027531

	Brief description	Type	Part no.
	Head A: cable Head B: Flying leads Cable: SSI, TTL, HTL, Incremental, PUR, halogen-free, shielded	LTG-2612-MW	6028516
	Head A: male connector, M12, 8-pin, straight, A-coded Head B: - Cable: Incremental, shielded	STE-1208-GA01	6044892
	Head A: male connector, M23, 12-pin, straight Head B: - Cable: HIPERFACE <sup>®</sup> , SSI, Incremental, shielded	STE-2312-G01	2077273
		STE-2312-GX	6028548

## SICK AT A GLANCE

SICK is one of the leading manufacturers of intelligent sensors and sensor solutions for industrial applications. A unique range of products and services creates the perfect basis for controlling processes securely and efficiently, protecting individuals from accidents and preventing damage to the environment.

We have extensive experience in a wide range of industries and understand their processes and requirements. With intelligent sensors, we can deliver exactly what our customers need. In application centers in Europe, Asia and North America, system solutions are tested and optimized in accordance with customer specifications. All this makes us a reliable supplier and development partner.

Comprehensive services complete our offering: SICK LifeTime Services provide support throughout the machine life cycle and ensure safety and productivity.

For us, that is “Sensor Intelligence.”

## WORLDWIDE PRESENCE:

Contacts and other locations –[www.sick.com](http://www.sick.com)