



# HTB18-B4A2BH

SureSense

HYBRID PHOTOELECTRIC SENSORS

**SICK**  
Sensor Intelligence.



Illustration may differ



### Ordering information

Type	Part no.
HTB18-B4A2BH	1080340

Other models and accessories → [www.sick.com/SureSense](http://www.sick.com/SureSense)

### Detailed technical data

#### Features

<b>Device version</b>	Standard
<b>Sensor/ detection principle</b>	Photoelectric proximity sensor, Background suppression
<b>Dimensions (W x H x D)</b>	16.2 mm x 48.5 mm x 31.8 mm
<b>Housing design (light emission)</b>	Hybrid
<b>Thread diameter (housing)</b>	M18
<b>Mounting system type</b>	M18, nose / side (24.1 ... 25.4 mm)
<b>Housing color</b>	Blue
<b>Sensing range max.</b>	5 mm ... 300 mm <sup>1)</sup>
<b>Sensing range</b>	5 mm ... 150 mm <sup>2)</sup>
<b>Type of light</b>	Visible red light
<b>Light source</b>	PinPoint LED <sup>3)</sup>
<b>Light spot size (distance)</b>	7 mm (300 mm)
<b>Wave length</b>	631 nm
<b>Adjustment</b>	
	Potentiometer, right Sensing range
	Potentiometer, left Light/dark switching
<b>Special features</b>	Signal strength light bar

<sup>1)</sup> Object with 90 % reflectance (referred to standard white, DIN 5033).

<sup>2)</sup> Object with 6 % reflectance (referred to standard black, DIN 5033).

<sup>3)</sup> Average service life: 100,000 h at T<sub>U</sub> = +25 °C.

## Mechanics/electronics

<b>Supply voltage</b>	10 V DC ... 30 V DC
<b>Ripple</b>	< 5 V <sub>pp</sub> <sup>1)</sup>
<b>Current consumption</b>	20 mA <sup>2)</sup>
<b>Switching output</b>	PNP NPN
<b>Switching mode</b>	Light switching
<b>Switching output detail</b>	
Switching output Q1	PNP, Light switching
Switching output Q2	NPN, Light switching
<b>Output current I<sub>max.</sub></b>	≤ 100 mA
<b>Response time</b>	≤ 0.5 ms <sup>3)</sup>
<b>Switching frequency</b>	1,000 Hz <sup>4)</sup>
<b>Connection type</b>	Male connector M12, 4-pin
<b>Circuit protection</b>	A <sup>5)</sup> B <sup>6)</sup> D <sup>7)</sup>
<b>Protection class</b>	III
<b>Weight</b>	18 g
<b>Housing material</b>	Plastic, VISTAL®
<b>Optics material</b>	Plastic, PMMA
<b>Enclosure rating</b>	IP67 IP69K
<b>Items supplied</b>	Mounting nut (1x), M18, plastic, black, flat
<b>EMC</b>	EN 60947-5-2 (The sensor complies with the Radio Safety Requirements (EMC) for the industrial sector (Radio Safety Class A). It may cause radio interference if used in a residential area.)
<b>Ambient operating temperature</b>	-40 °C ... +65 °C
<b>Ambient storage temperature</b>	-40 °C ... +75 °C
<b>UL File No.</b>	E189383

<sup>1)</sup> May not exceed or fall below U<sub>v</sub> tolerances.

<sup>2)</sup> Without signal strength light bar and load.

<sup>3)</sup> Signal transit time with resistive load.

<sup>4)</sup> With light/dark ratio 1:1.

<sup>5)</sup> A = V<sub>S</sub> connections reverse-polarity protected.

<sup>6)</sup> B = inputs and output reverse-polarity protected.

<sup>7)</sup> D = outputs overcurrent and short-circuit protected.

## Safety-related parameters

<b>MTTF<sub>D</sub></b>	523.9 years
<b>DC<sub>avg</sub></b>	0%

## Classifications

<b>ECl@ss 5.0</b>	27270904
<b>ECl@ss 5.1.4</b>	27270904
<b>ECl@ss 6.0</b>	27270904
<b>ECl@ss 6.2</b>	27270904

<b>ECl@ss 7.0</b>	27270904
<b>ECl@ss 8.0</b>	27270904
<b>ECl@ss 8.1</b>	27270904
<b>ECl@ss 9.0</b>	27270904
<b>ECl@ss 10.0</b>	27270904
<b>ECl@ss 11.0</b>	27270904
<b>ETIM 5.0</b>	EC002719
<b>ETIM 6.0</b>	EC002719
<b>ETIM 7.0</b>	EC002719
<b>UNSPSC 16.0901</b>	39121528

### Connection/PIN assignment

<b>Connection type</b>	Male connector M12, 4-pin
<b>PIN assignment</b>	
BN 1	+ (L+)
WH 2	Q <sub>2</sub>
BU 3	- (M)
BK 4	Q <sub>1</sub>

### Dimensional drawing (Dimensions in mm (inch))

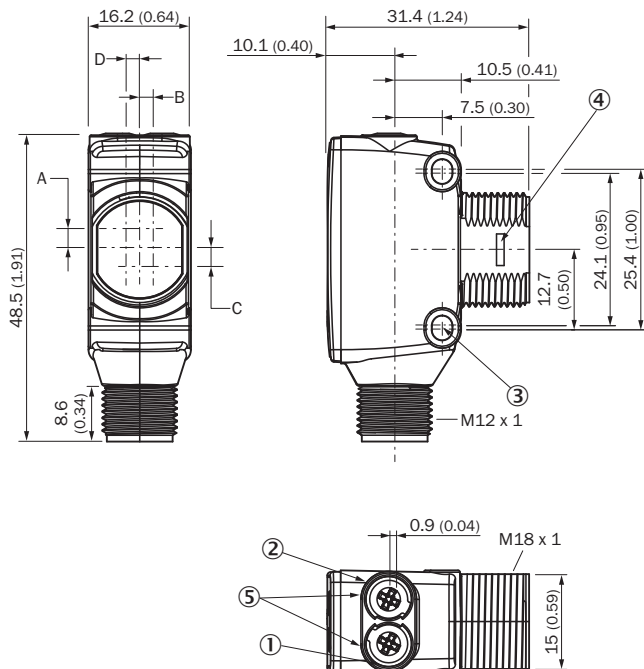

- ① LED indicator yellow: Status of received light beam
- ② LED indicator green: power on
- ③ M3 mounting hole
- ④ Snap Connection for flush ring (sold separately)
- ⑤ Potentiometer (if selected) or LED Indicators

Dimensions in mm (inch)	Receiver		Sender	
	A	B	C	D

Dimensions in mm (inch)	Receiver		Sender	
<b>HTB18 / HTF18</b>	- 1.1 (0.04)	1.1 (0.04)	4.7 (0.19)	0.6 (0.02)
<b>HTE18 / HL18 / HSE18</b>	2.5 (0.1)	0.0 (0.0)	4.0 (0.16)	0.0 (0.0)
<b>HTB18L / HTF18L / HL18L / HSE18L</b>	2.5 (0.1)	0.0 (0.0)	3.5 (0.14)	0.0 (0.0)

### Connection type

See table: Connection/PIN assignment

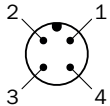

### Adjustments possible

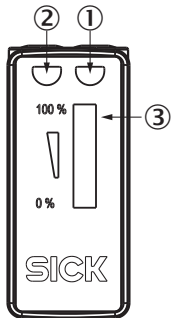

- ① LED indicator yellow: Status of received light beam
- ② LED indicator green: power on
- ③ Signal strength light bar

### Characteristic curve

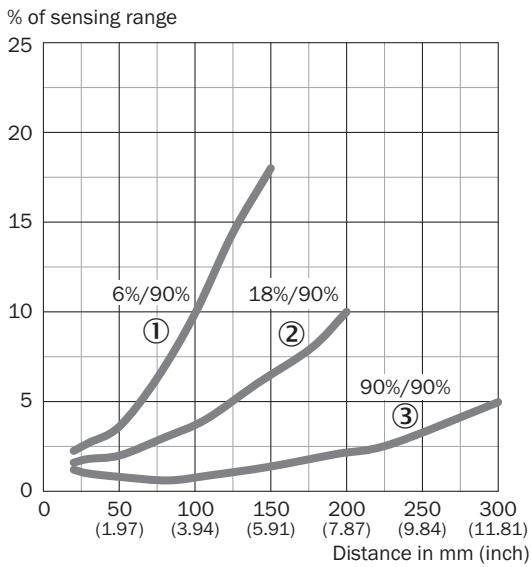

- ① Sensing range on black, 6% remission
- ② Sensing range on gray, 18 % remission
- ③ Sensing range on white, 90% remission

### Light spot size

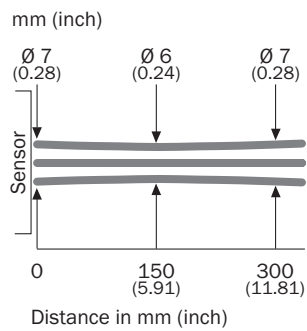

### Sensing range diagram

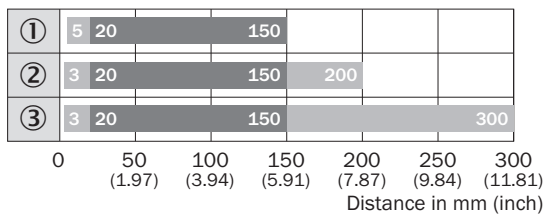

■ Sensing range      ■ Sensing range max.

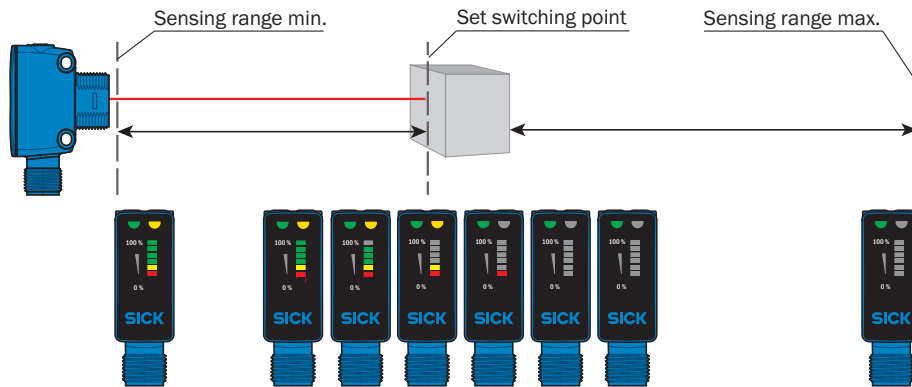

- ① Sensing range on black, 6% remission
- ② Sensing range on gray, 18 % remission
- ③ Sensing range on white, 90% remission

### Functions



### Recommended accessories

Other models and accessories → [www.sick.com/SureSense](http://www.sick.com/SureSense)

	Brief description	Type	Part no.
Plug connectors and cables			
	Head A: female connector, M12, 4-pin, straight, A-coded Head B: Flying leads Cable: Sensor/actuator cable, PVC, unshielded, 5 m	YF2A14-050VB3XLEAX	2096235
	Head A: male connector, M12, 4-pin, straight Head B: - Cable: unshielded	STE-1204-G	6009932

## SICK AT A GLANCE

SICK is one of the leading manufacturers of intelligent sensors and sensor solutions for industrial applications. A unique range of products and services creates the perfect basis for controlling processes securely and efficiently, protecting individuals from accidents and preventing damage to the environment.

We have extensive experience in a wide range of industries and understand their processes and requirements. With intelligent sensors, we can deliver exactly what our customers need. In application centers in Europe, Asia and North America, system solutions are tested and optimized in accordance with customer specifications. All this makes us a reliable supplier and development partner.

Comprehensive services complete our offering: SICK LifeTime Services provide support throughout the machine life cycle and ensure safety and productivity.

For us, that is “Sensor Intelligence.”

## WORLDWIDE PRESENCE:

Contacts and other locations –[www.sick.com](http://www.sick.com)