



# AFM60B-TGAK008192

AFS/AFM60 SSI

ABSOLUTE ENCODERS

**SICK**  
Sensor Intelligence.



Illustration may differ



### Ordering information

Type	Part no.
AFM60B-TGAK008192	1078516

Other models and accessories → [www.sick.com/AFS\\_AFM60\\_SSI](http://www.sick.com/AFS_AFM60_SSI)

### Detailed technical data

#### Performance

<b>Max. resolution (number of steps per revolution x number of revolutions)</b>	13 bit x 12 bit (8,192 x 4,096)
<b>Error limits G</b>	0.05° <sup>1)</sup>
<b>Repeatability standard deviation <math>\sigma_r</math></b>	0.002° <sup>2)</sup>

<sup>1)</sup> In accordance with DIN ISO 1319-1, position of the upper and lower error limit depends on the installation situation, specified value refers to a symmetrical position, i.e. deviation in upper and lower direction is the same.

<sup>2)</sup> In accordance with DIN ISO 55350-13; 68.3% of the measured values are inside the specified area.

#### Interfaces

<b>Communication interface</b>	SSI
<b>Initialization time</b>	50 ms <sup>1)</sup>
<b>Position forming time</b>	< 1 $\mu$ s
<b>SSI</b>	
Code type	Gray
Code sequence parameter adjustable	CW/CCW (V/R) parameter adjustable
Clock frequency	$\leq 2$ MHz <sup>2)</sup>
Set (electronic adjustment)	H-active (L = 0 - 3 V, H = 4,0 - U <sub>s</sub> V)
CW/CCW (counting sequence when turning)	L-active (L = 0 - 1,5 V, H = 2,0 - U <sub>s</sub> V)
<b>Sin/Cos</b>	
Load resistance	$\geq 120 \Omega$

<sup>1)</sup> Valid positional data can be read once this time has elapsed.

<sup>2)</sup> Minimum, LOW level (Clock +): 250 ns.

#### Electrical data

<b>Connection type</b>	Cable, 8-wire, universal, 1.5 m <sup>1)</sup>
<b>Supply voltage</b>	4.5 ... 32 V DC

<sup>1)</sup> The universal cable connection is positioned so that it is possible to lay it without bends in a radial or axial direction.

<sup>2)</sup> This product is a standard product and does not constitute a safety component as defined in the Machinery Directive. Calculation based on nominal load of components, average ambient temperature 40°C, frequency of use 8760 h/a. All electronic failures are considered hazardous. For more information, see document no. 8015532.

<b>Power consumption</b>	≤ 0.7 W (without load)
<b>Reverse polarity protection</b>	✓
<b>MTTFd: mean time to dangerous failure</b>	250 years (EN ISO 13849-1) <sup>2)</sup>

<sup>1)</sup> The universal cable connection is positioned so that it is possible to lay it without bends in a radial or axial direction.

<sup>2)</sup> This product is a standard product and does not constitute a safety component as defined in the Machinery Directive. Calculation based on nominal load of components, average ambient temperature 40 °C, frequency of use 8760 h/a. All electronic failures are considered hazardous. For more information, see document no. 8015532.

## Mechanical data

<b>Mechanical design</b>	Through hollow shaft
<b>Shaft diameter</b>	14 mm
<b>Weight</b>	0.2 kg <sup>1)</sup>
<b>Shaft material</b>	Stainless steel
<b>Flange material</b>	Aluminum
<b>Housing material</b>	Aluminum die cast
<b>Start up torque</b>	< 0.8 Ncm <sup>2) 2)</sup>
<b>Operating torque</b>	< 0.6 Ncm <sup>2) 2)</sup>
<b>Permissible movement static</b>	± 0.5 mm (axial) ± 0.3 mm (radial)
<b>Permissible movement dynamic</b>	± 0.2 mm (axial) ± 0.1 mm (radial)
<b>Moment of inertia of the rotor</b>	40 gcm <sup>2</sup>
<b>Bearing lifetime</b>	3.0 x 10 <sup>9</sup> revolutions
<b>Angular acceleration</b>	+ 500,000 rad/s <sup>2</sup>
<b>Operating speed</b>	≤ 9,000 min <sup>-1</sup> <sup>3)</sup>

<sup>1)</sup> Relates to devices with male connector.

<sup>2)</sup> At 20 °C.

<sup>3)</sup> Allow for self-heating of 3.3 K per 1,000 rpm when designing the operating temperature range.

## Ambient data

<b>EMC</b>	According to EN 61000-6-2 and EN 61000-6-3 <sup>1)</sup>
<b>Enclosure rating</b>	IP65, shaft side (according to IEC 60529) IP67, housing side (according to IEC 60529) <sup>2)</sup>
<b>Permissible relative humidity</b>	90 % (condensation of the optical scanning not permitted)
<b>Operating temperature range</b>	-40 °C ... +100 °C <sup>3)</sup>
<b>Storage temperature range</b>	-40 °C ... +100 °C, without package
<b>Resistance to shocks</b>	70 g, 6 ms (according to EN 60068-2-27)
<b>Resistance to vibration</b>	30 g, 10 Hz ... 2,000 Hz (according to EN 60068-2-6)

<sup>1)</sup> EMC according to the standards quoted is achieved if shielded cables are used.

<sup>2)</sup> For devices with male connector: With mating connector mounted.

<sup>3)</sup> Stationary position of the cable.

## Classifications

<b>ECl@ss 5.0</b>	27270502
<b>ECl@ss 5.1.4</b>	27270502
<b>ECl@ss 6.0</b>	27270590

<b>ECl@ss 6.2</b>	27270590
<b>ECl@ss 7.0</b>	27270502
<b>ECl@ss 8.0</b>	27270502
<b>ECl@ss 8.1</b>	27270502
<b>ECl@ss 9.0</b>	27270502
<b>ECl@ss 10.0</b>	27270502
<b>ECl@ss 11.0</b>	27270502
<b>ETIM 5.0</b>	EC001486
<b>ETIM 6.0</b>	EC001486
<b>ETIM 7.0</b>	EC001486
<b>UNSPSC 16.0901</b>	41112113

### Dimensional drawing (Dimensions in mm (inch))

Through hollow shaft, cable connection

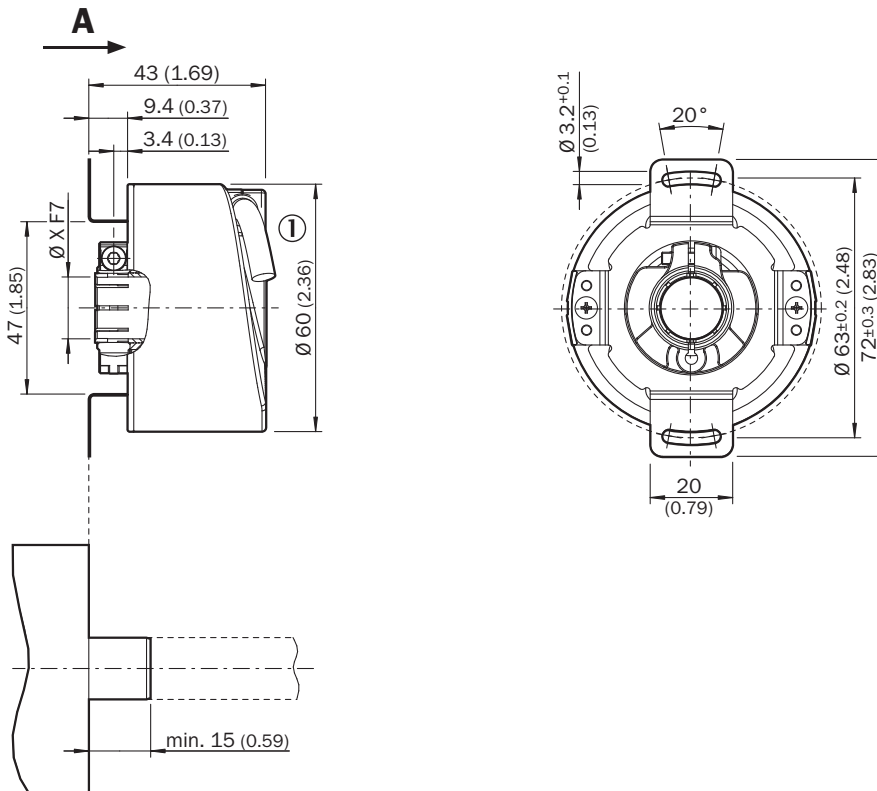

General tolerances according to DIN ISO 2768-mk

① Cable diameter = 5.6 mm +/- 0.2 mm bend radius = 30 mm

## PIN assignment

M12 male connector, 8-pin and cable, 8-wire, SSI/Gray

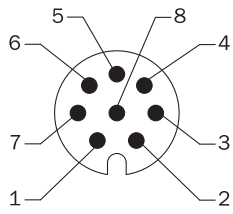

View of M12 male device connector on encoder

## Maximum revolution range

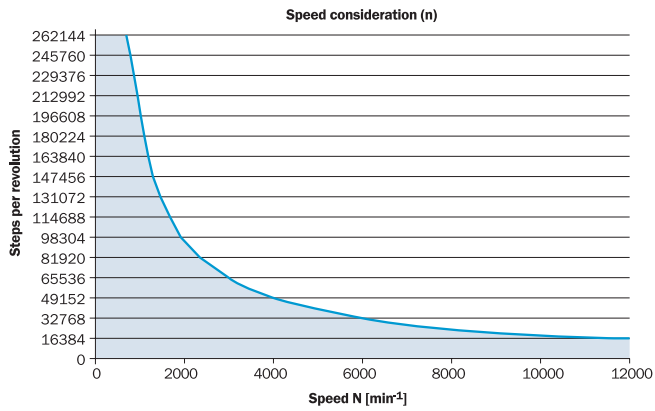

The maximum speed is also dependent on the shaft type.

Diagrams

SSI data format singleturn



**Bit 1–18: Position Bits**

- LSB: Least significant Bit
- MSB: Most significant Bit

**Bit 19–21: Error Bits**

- ERRDIG: Failure message about speed. If this failure occurs during the position building procedure it will be indicated by the ERRDIG-Bit.
- ERRSI: Light source monitoring failure.
- ERRSYNC: Contamination of the disc or scanning system. During the determination of the position, an error has occurred since the last SSI transmission. The error bit will be deleted during the next data transmission.

**The evaluation of the error bits has to be realized in the PLC.**

The provided error bits don't have to be used by the PLC compulsorily.

**Example**

If the resolution of the absolute encoder is set on 13 bits, 16 bits are provided by the encoder: 13 data bits and 3 error bits. If the PLC is not able to evaluate the error bits, the PLC has to be set on a resolution of 13 bits. Then the error bits have to be masked out by the PLC.

SSI data format multiturn

**30 Bits**

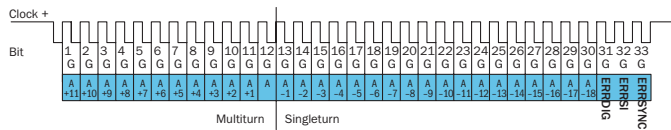

- Bit 1–12:** Position Bits multiturn
- Bit 13–30:** Position Bits singleturn
- Bit 31–33:** Error Bits

**27 Bits**

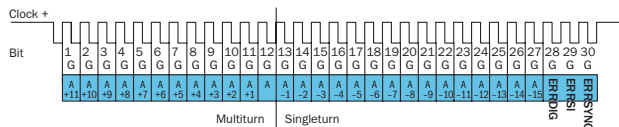

- Bit 1–12:** Position Bits multiturn
- Bit 13–27:** Position Bits singleturn
- Bit 28–30:** Error Bits

**Error Bits**

- ERRDIG: Failure message about speed. If this failure occurs during the position building procedure it will be indicated by the ERRDIG-Bit.
- ERRSI: Light source monitoring failure.
- ERRSYNC: Contamination of the disc or scanning system. During the determination of the position, an error has occurred since the last SSI transmission. The error bit will be deleted during the next data transmission.

**The evaluation of the error bits has to be realized in the PLC.**

The provided error bits don't have to be used by the PLC compulsorily. The multiturn resolution is fixed on 12 bits.

**Example**

If the resolution of the absolute encoder is set on 27 bits, 30 bits are provided by the encoder: 27 data bits and 3 error bits. If the PLC is not able to evaluate the error bits, the PLC has to be set on a resolution of 27 bits. Then the error bits have to be masked out by the PLC.

**Electrical interfaces sine 0.5 V<sub>pp</sub>**

Power supply	Output
4.5 ... 5.5 V	Sine 0.5 V <sub>pp</sub>

Signal before differential generation at load 120 Ω at U<sub>s</sub> = 5 V

Signal diagram for clockwise rotation of the shaft looking in direction "A" (shaft)



Interface signals Sin, $\overline{\text{Sin}}$ , Cos, $\overline{\text{Cos}}$	Signal before differential generation at load 120 Ω	Signal offset
Analog differential	0.5 V <sub>pp</sub> ± 20 %	2.5 V ± 10 %

Signal after differential generation at load 120 Ω at U<sub>s</sub> = 5 V

Signal diagram for clockwise rotation of the shaft looking in direction "A" (shaft)





**Electrical interfaces HTL/TTL**

Incremental pulse diagram for clockwise rotation of the shaft looking in direction "A", see dimensional drawing



### Recommended accessories

Other models and accessories → [www.sick.com/AFS\\_AFM60\\_SSI](http://www.sick.com/AFS_AFM60_SSI)

	Brief description	Type	Part no.
Plug connectors and cables			
	Head A: male connector, M12, 8-pin, straight, A-coded Head B: - Cable: Incremental, shielded	STE-1208-GA01	6044892
	Head A: male connector, M23, 12-pin, straight Head B: - Cable: HIPERFACE®, SSI, Incremental, RS-422, shielded	STE-2312-G	6027537
	Head A: male connector, M23, 12-pin, straight Head B: - Cable: HIPERFACE®, SSI, Incremental, shielded	STE-2312-G01	2077273
		STE-2312-GX	6028548

## SICK AT A GLANCE

SICK is one of the leading manufacturers of intelligent sensors and sensor solutions for industrial applications. A unique range of products and services creates the perfect basis for controlling processes securely and efficiently, protecting individuals from accidents and preventing damage to the environment.

We have extensive experience in a wide range of industries and understand their processes and requirements. With intelligent sensors, we can deliver exactly what our customers need. In application centers in Europe, Asia and North America, system solutions are tested and optimized in accordance with customer specifications. All this makes us a reliable supplier and development partner.

Comprehensive services complete our offering: SICK LifeTime Services provide support throughout the machine life cycle and ensure safety and productivity.

For us, that is “Sensor Intelligence.”

## WORLDWIDE PRESENCE:

Contacts and other locations –[www.sick.com](http://www.sick.com)