



# WSE2S-2P3030S02

W2S-2

MINIATURE PHOTOELECTRIC SENSORS

**SICK**  
Sensor Intelligence.



### Ordering information

Type	Part no.
WSE2S-2P3030S02	1069003

Other models and accessories → [www.sick.com/W2S-2](http://www.sick.com/W2S-2)

Illustration may differ



### Detailed technical data

#### Features

<b>Sensor/ detection principle</b>	Through-beam photoelectric sensor
<b>Dimensions (W x H x D)</b>	7.7 mm x 21.8 mm x 13.5 mm
<b>Housing design (light emission)</b>	Rectangular
<b>Sensing range max.</b>	0 m ... 2.5 m
<b>Sensing range</b>	0 m ... 2 m
<b>Type of light</b>	Visible red light
<b>Light source</b>	PinPoint LED <sup>1)</sup>
<b>Light spot size (distance)</b>	Ø 65 mm (1,500 mm)
<b>Wave length</b>	640 nm
<b>Adjustment</b>	None

<sup>1)</sup> Average service life: 100,000 h at T<sub>J</sub> = +25 °C.

#### Mechanics/electronics

<b>Supply voltage</b>	10 V DC ... 30 V DC <sup>1)</sup>
<b>Ripple</b>	≤ 5 V <sub>pp</sub> <sup>2)</sup>

<sup>1)</sup> Limit values.

<sup>2)</sup> May not exceed or fall below U<sub>V</sub> tolerances.

<sup>3)</sup> Without load.

<sup>4)</sup> Signal transit time with resistive load.

<sup>5)</sup> With light/dark ratio 1:1.

<sup>6)</sup> Do not bend below 0 °C.

<sup>7)</sup> A = V<sub>S</sub> connections reverse-polarity protected.

<sup>8)</sup> B = output reverse-polarity protected.

<sup>9)</sup> D = outputs overcurrent and short-circuit protected.

<b>Current consumption</b>	20 mA <sup>3)</sup>
<b>Switching output</b>	PNP
<b>Switching mode</b>	Light switching
<b>Output current I<sub>max.</sub></b>	< 50 mA
<b>Response time</b>	< 0.4 ms <sup>4)</sup>
<b>Switching frequency</b>	1,200 Hz <sup>5)</sup>
<b>Connection type</b>	Cable with connector M8, 3-pin, 700 mm <sup>6)</sup>
<b>Cable material</b>	PVC
<b>Cable diameter</b>	Ø 3 mm
<b>Circuit protection</b>	A <sup>7)</sup> B <sup>8)</sup> D <sup>9)</sup>
<b>Special device</b>	✓
<b>Housing material</b>	Plastic, ABS/PC
<b>Optics material</b>	Plastic, PMMA
<b>Enclosure rating</b>	IP67
<b>Ambient operating temperature</b>	-25 °C ... +50 °C
<b>Ambient storage temperature</b>	-40 °C ... +75 °C
<b>UL File No.</b>	NRKH.E181493
<b>Part number of individual components</b>	2071150 WSE2S-2 2073983 WS2S-2D3030S01

- 1) Limit values.  
 2) May not exceed or fall below U<sub>v</sub> tolerances.  
 3) Without load.  
 4) Signal transit time with resistive load.  
 5) With light/dark ratio 1:1.  
 6) Do not bend below 0 °C.  
 7) A = V<sub>S</sub> connections reverse-polarity protected.  
 8) B = output reverse-polarity protected.  
 9) D = outputs overcurrent and short-circuit protected.

## Classifications

<b>ECl@ss 5.0</b>	27270901
<b>ECl@ss 5.1.4</b>	27270901
<b>ECl@ss 6.0</b>	27270901
<b>ECl@ss 6.2</b>	27270901
<b>ECl@ss 7.0</b>	27270901
<b>ECl@ss 8.0</b>	27270901
<b>ECl@ss 8.1</b>	27270901
<b>ECl@ss 9.0</b>	27270901
<b>ECl@ss 10.0</b>	27270901
<b>ECl@ss 11.0</b>	27270901
<b>ETIM 5.0</b>	EC002716
<b>ETIM 6.0</b>	EC002716
<b>ETIM 7.0</b>	EC002716

UNSPSC 16.0901

39121528

Connection diagram

Cd-051

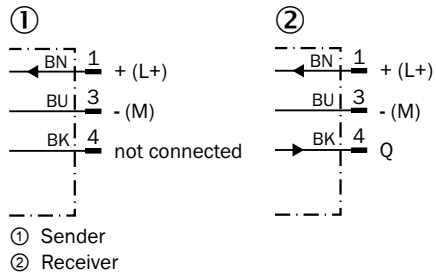

Characteristic curve

WSE2S-2

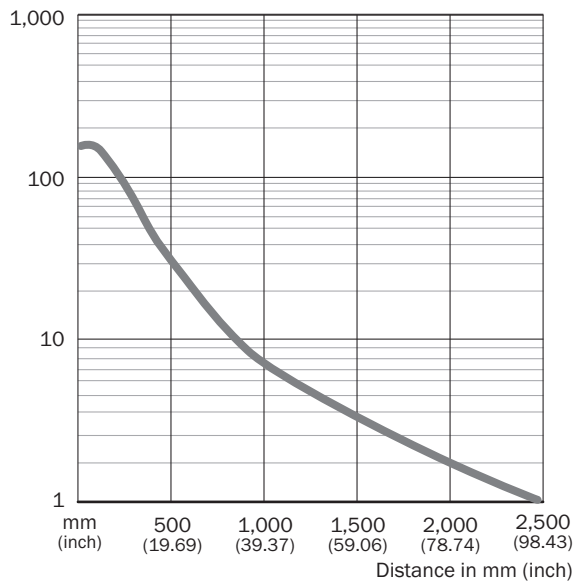

### Light spot size

WSE2S-2

Spot diameter in mm (inch)

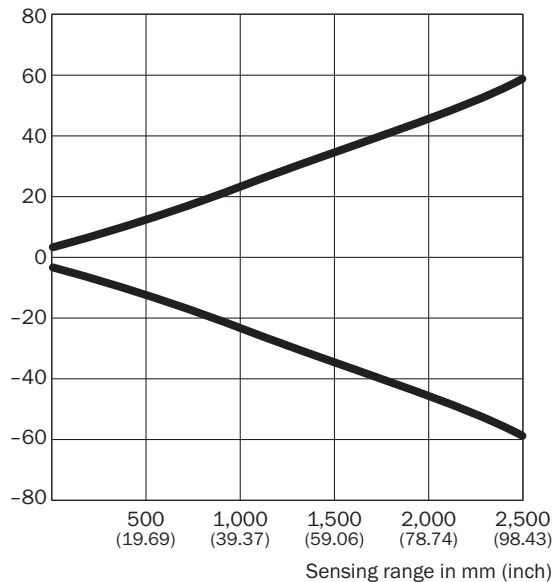

### Dimensions in mm (inch)

Sensing range	Spot diameter
<b>10</b> (0.39)	4.0 (0.16)
<b>250</b> (9.84)	13.0 (0.51)
<b>500</b> (19.69)	23.0 (0.91)
<b>1,000</b> (39.37)	45.0 (1.77)
<b>1,500</b> (59.06)	65.0 (2.56)
<b>2,500</b> (98.43)	116.0 (4.57)

### Sensing range diagram

WSE2S-2

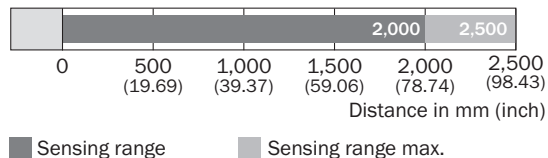

■ Sensing range

■ Sensing range max.

**Dimensional drawing** (Dimensions in mm (inch))

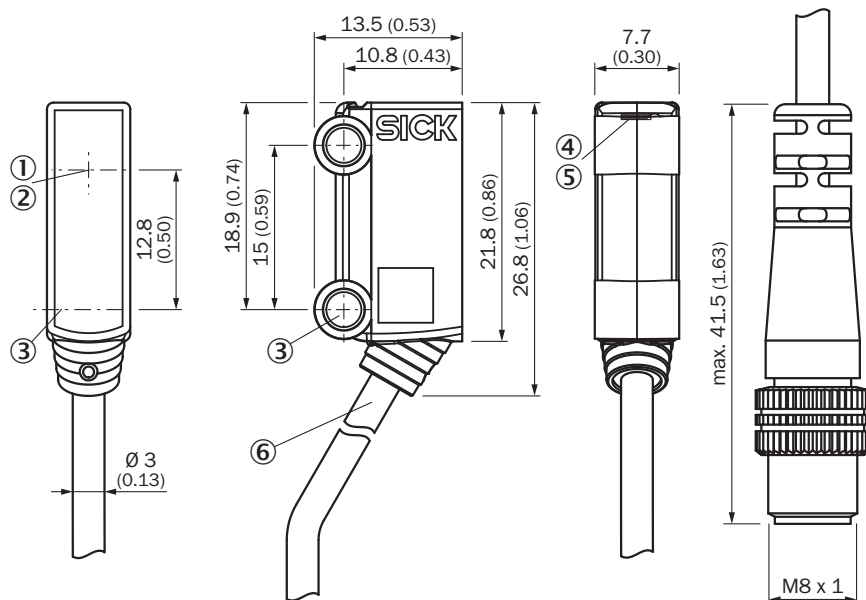

WSE2S-2



- ① Optical axis, receiver
- ② Optical axis, sender
- ③ Middle axis fixing hole  $\varnothing$  3.2 mm
- ④ LED indicator green: power on
- ⑤ LED indicator yellow: Status of received light beam
- ⑥ Connection

**Recommended accessories**

Other models and accessories → [www.sick.com/W2S-2](http://www.sick.com/W2S-2)

	Brief description	Type	Part no.
<b>Plug connectors and cables</b>			
	Head A: female connector, M8, 3-pin, straight, A-coded Head B: Flying leads Cable: Sensor/actuator cable, PVC, unshielded, 5 m	YF8U13-050VA1XLEAX	2095884
	Head A: male connector, M8, 3-pin, straight Head B: - Cable: unshielded	STE-0803-G	6037322

## SICK AT A GLANCE

SICK is one of the leading manufacturers of intelligent sensors and sensor solutions for industrial applications. A unique range of products and services creates the perfect basis for controlling processes securely and efficiently, protecting individuals from accidents and preventing damage to the environment.

We have extensive experience in a wide range of industries and understand their processes and requirements. With intelligent sensors, we can deliver exactly what our customers need. In application centers in Europe, Asia and North America, system solutions are tested and optimized in accordance with customer specifications. All this makes us a reliable supplier and development partner.

Comprehensive services complete our offering: SICK LifeTime Services provide support throughout the machine life cycle and ensure safety and productivity.

For us, that is “Sensor Intelligence.”

## WORLDWIDE PRESENCE:

Contacts and other locations –[www.sick.com](http://www.sick.com)