



# CFP0400-XPBNNAX

CFP Cubic

LEVEL SENSORS

**SICK**  
Sensor Intelligence.



Illustration may differ



### Ordering information

Type	Part no.
CFP0400-XPBNNAX	1083240

Other models and accessories → [www.sick.com/CFP\\_Cubic](http://www.sick.com/CFP_Cubic)

### Detailed technical data

#### Features

<b>Medium</b>	Water and oil-based liquids
<b>Measurement</b>	Switch, Continuous
<b>Probe length</b>	400 mm
<b>Process pressure</b>	-0.5 bar ... 3 bar
<b>Process temperature</b>	-20 °C ... +80 °C
<b>UL approval</b>	✓
<b>RoHS certificate</b>	✓
<b>IO-Link</b>	✓

#### Performance

<b>Accuracy of sensor element</b>	± 15 mm (with water or oil under reference conditions)
<b>Reproducibility</b>	< 5 mm
<b>Resolution</b>	< 2 mm
<b>Response time</b>	< 300 ms
<b>Dielectricity constant</b>	≥ 2
<b>Conductivity</b>	No limitation
<b>Deactivated area at end of probe</b>	7 mm ... 15 mm, Depending on probe length

#### Electronics

<b>Supply voltage</b>	10 V DC ... 30 V DC <sup>1)</sup>
<b>Power consumption</b>	≤ 100 mA at 24 V DC without output load
<b>Initialization time</b>	≤ 4 s

<sup>1)</sup> All connections are polarity protected. All outputs are overload and short-circuit protected.

<b>Protection class</b>	III
<b>Connection type</b>	Round connector M12 x 1, 5-pin
<b>Output signal</b>	2 x PNP/NPN/push-pull transistor outputs switchable
<b>Output load</b>	4 mA ... 20 mA < 500 Ohm at $U_v > 15$ V, 4 mA ... 20 mA < 350 Ohm at $U_v > 12$ V, 0 V ... 10 V > 750 Ohm at $U_v 14 \geq$ V
<b>Hysteresis</b>	Min. 3 mm, min. 2 °C, free adjustable
<b>Signal voltage HIGH</b>	$U_v - 3$ V
<b>Signal voltage LOW</b>	< 3 V
<b>Output current</b>	< 100 mA
<b>Inductive load</b>	< 1 H
<b>Capacitive load</b>	100 nF
<b>Enclosure rating</b>	IP65 / IP67
<b>Temperature drift</b>	< 0.1 mm/K
<b>Lower signal level</b>	3.8 mA ... 4 mA
<b>Upper signal level</b>	20 mA ... 20.5 mA
<b>Resolution of analog output</b>	12 bit

<sup>1)</sup> All connections are polarity protected. All outputs are overload and short-circuit protected.

## Mechanics

<b>Wetted parts</b>	Outer tube: polypropylene (PP-H), G $\frac{3}{4}$ " and $\frac{3}{4}$ " NPT: PPSU, Easy-clamp bracket: PP
<b>Process connection</b>	$\frac{3}{4}$ " NPT
<b>Housing material</b>	PBT / PC
<b>Max. probe load</b>	$\leq 4$ Nm
<b>Probe diameter</b>	16 mm

## Ambient data

<b>Ambient operating temperature</b>	-20 °C ... +60 °C
<b>Ambient storage temperature</b>	-40 °C ... +80 °C

## Classifications

<b>ECl@ss 5.0</b>	27200503
<b>ECl@ss 5.1.4</b>	27200503
<b>ECl@ss 6.0</b>	27200503
<b>ECl@ss 6.2</b>	27200503
<b>ECl@ss 7.0</b>	27200503
<b>ECl@ss 8.0</b>	27200503
<b>ECl@ss 8.1</b>	27200503
<b>ECl@ss 9.0</b>	27200503
<b>ECl@ss 10.0</b>	27200503
<b>ECl@ss 11.0</b>	27200503
<b>ETIM 5.0</b>	EC001447
<b>ETIM 6.0</b>	EC001447
<b>ETIM 7.0</b>	EC001447
<b>UNSPSC 16.0901</b>	41113710

### Type code

#### Probe length in mm

0100	100 mm (in increments of 50 mm)
0500	500 mm (in increments of 100 mm)
1000	1,000 mm

#### Special design

**P** Rod probe from PP

#### Process connection

<b>X</b>	Without process connection
<b>A</b>	G 3/4 A; made from PBT
<b>B</b>	3/4" NPT; made from PBT

#### Application type

**N** Oil and water application

#### Housing

**N** Plastic housing with display

#### Electrical output

<b>A</b>	2 digital outputs
<b>B</b>	2 digital outputs + 1 analog output
<b>C</b>	4 digital outputs + 2 analog outputs

#### Additional option

<b>T</b>	With temperature sensor
<b>X</b>	No additional options

CFP - X P N N

Not all variants of the type code can be combined!

Dimensional drawing (Dimensions in mm (inch))

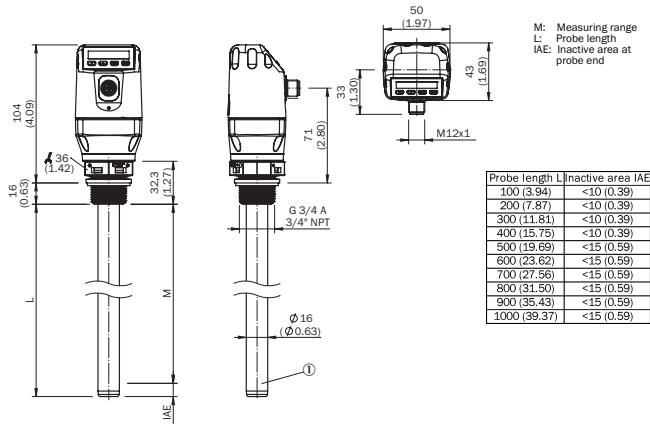



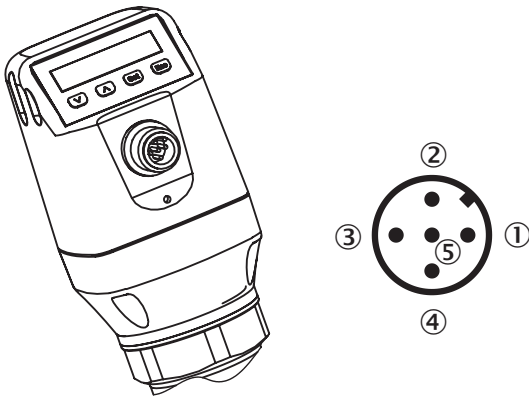





## Connection type







- ① L<sup>+</sup>: Supply voltage
- ② Q<sub>A</sub>: Analog current-/voltage output
- ③ M: Ground, reference ground for current-/voltage output
- ④ C/Q1: Switching output 2, PNP/NPN/DRV (Push-Pull) / IO-Link
- ⑤ Q<sub>2</sub>: Switching output 2, PNP/NPN/DRV (Push-Pull)

## Recommended accessories

Other models and accessories → [www.sick.com/CFP\\_Cubic](http://www.sick.com/CFP_Cubic)

	Brief description	Type	Part no.
<b>Plug connectors and cables</b>			
	Head A: female connector, M12, 5-pin, straight, A-coded Head B: Flying leads Cable: Sensor/actuator cable, PUR, halogen-free, unshielded, 2 m	YF2A15-020UB5XLEAX	2095617
	Head A: female connector, M12, 5-pin, straight, A-coded Head B: Flying leads Cable: Sensor/actuator cable, PVC, unshielded, 2 m	YF2A15-020VB5XLEAX	2096239
	Head A: female connector, M12, 5-pin, straight, A-coded Head B: Flying leads Cable: Sensor/actuator cable, PUR, halogen-free, unshielded, 5 m	YF2A15-050UB5XLEAX	2095618
	Head A: female connector, M12, 5-pin, straight, A-coded Head B: Flying leads Cable: Sensor/actuator cable, PVC, unshielded, 5 m	YF2A15-050VB5XLEAX	2096240
	Head A: female connector, M12, 5-pin, straight, A-coded Head B: Flying leads Cable: Sensor/actuator cable, PUR, halogen-free, unshielded, 10 m	YF2A15-100UB5XLEAX	2095619
	Head A: female connector, M12, 5-pin, straight, A-coded Head B: Flying leads Cable: Sensor/actuator cable, PVC, unshielded, 10 m	YF2A15-100VB5XLEAX	2096241
	Head A: female connector, M12, 5-pin, angled, A-coded Head B: Flying leads Cable: Sensor/actuator cable, PUR, halogen-free, unshielded, 2 m	YG2A15-020UB5XLEAX	2095772
	Head A: female connector, M12, 5-pin, angled, A-coded Head B: Flying leads Cable: Sensor/actuator cable, PVC, unshielded, 2 m	YG2A15-020VB5XLEAX	2096215

	Brief description	Type	Part no.
	Head A: female connector, M12, 5-pin, angled, A-coded Head B: Flying leads Cable: Sensor/actuator cable, PUR, halogen-free, unshielded, 5 m	YG2A15-050UB5XLEAX	2095773
	Head A: female connector, M12, 5-pin, angled, A-coded Head B: Flying leads Cable: Sensor/actuator cable, PVC, unshielded, 5 m	YG2A15-050VB5XLEAX	2096216
	Head A: female connector, M12, 5-pin, angled, A-coded Head B: Flying leads Cable: Sensor/actuator cable, PUR, halogen-free, unshielded, 10 m	YG2A15-100UB5XLEAX	2095774
	Head A: female connector, M12, 5-pin, angled, A-coded Head B: Flying leads Cable: Sensor/actuator cable, PVC, unshielded, 10 m	YG2A15-100VB5XLEAX	2096217

### Recommended services

Additional services → [www.sick.com/CFP\\_Cubic](http://www.sick.com/CFP_Cubic)

	Type	Part no.
Function Block Factory		
<ul style="list-style-type: none"> <li><b>Description:</b> The Function Block Factory supports common programmable logic controllers (PLCs) from various manufacturers, such as Siemens, Beckhoff, Rockwell Automation and B&amp;R. More information on the FBF can be found <a _blank"="" href="https://fbf.cloud.sick.com target=">here</a>.</li> </ul>	Function Block Factory	On request

## SICK AT A GLANCE

SICK is one of the leading manufacturers of intelligent sensors and sensor solutions for industrial applications. A unique range of products and services creates the perfect basis for controlling processes securely and efficiently, protecting individuals from accidents and preventing damage to the environment.

We have extensive experience in a wide range of industries and understand their processes and requirements. With intelligent sensors, we can deliver exactly what our customers need. In application centers in Europe, Asia and North America, system solutions are tested and optimized in accordance with customer specifications. All this makes us a reliable supplier and development partner.

Comprehensive services complete our offering: SICK LifeTime Services provide support throughout the machine life cycle and ensure safety and productivity.

For us, that is “Sensor Intelligence.”

## WORLDWIDE PRESENCE:

Contacts and other locations –[www.sick.com](http://www.sick.com)