



DFS60S-TEOC01024

DFS60S Pro

SAFETY ENCODERS

SICK
Sensor Intelligence.



Illustration may differ



Ordering information

Type	Part no.
DFS60S-TEOC01024	1069529

Other models and accessories → www.sick.com/DFS60S_Pro

Detailed technical data

Safety-related parameters

Safety integrity level	SIL2 (IEC 61508), SILCL2 (IEC 62061) ¹⁾
Performance level	PL d (EN ISO 13849) ¹⁾
Category	3 (EN ISO 13849)
PFH_D: Probability of dangerous failure per hour	1.7×10^{-8} ²⁾
T_M (mission time)	20 years (EN ISO 13849)
Safety-related measuring step	0.09°, Quadrature analysis
Safety-related accuracy	± 0.09°

¹⁾ For more detailed information on the exact configuration of your machine/unit, please consult your relevant SICK branch office.

²⁾ The values displayed apply to a diagnostic degree of coverage of 99%, which must be achieved by the external drive system and 95 °C operating temperature.

Performance

Sine/cosine periods per revolution	1,024
Measuring step	0.3°, For interpolation of the sine/cosine signals with, e. g., 12 bits ¹⁾
Initialization time	50 ms ²⁾
Integral non-linearity	Typ. ± 45 Winkelsekunden (without mechanical tension of the stator coupling)
Differential non-linearity	± 7 Winkelsekunden
Reference signal, number	1
Reference signal, position	90°, electronically, gated with Sinus and Cosinus

¹⁾ Not safety-related.

²⁾ Valid signals can be read once this time has elapsed.

Electrical data

Communication interface	Incremental
Communication Interface detail	Sin/Cos ¹⁾
Connection type	Male connector, M12, 8-pin, radial
Supply voltage	4.5 V ... 32 V
Maximum output frequency	≤ 153.6 kHz
Load resistance	≥ 120 Ω
Power consumption max. without load	≤ 0.7 W
Power consumption	Without load
Reverse polarity protection	✓
Protection class	III (according to DIN EN 61140)
Short-circuit protection	✓ ²⁾

¹⁾ 1.0 V_{SS} (differential).

²⁾ Short-circuit to another channel or GND permitted for max. 30 s. In the case of U_S ≤ 12 V additional short-circuit to U_S permitted for max. 30 s.

Mechanical data

Mechanical design	Through hollow shaft with feather key groove
Shaft diameter	12 mm
Shaft material	Stainless steel
Flange material	Die-cast zinc
Housing material	Aluminum die cast
Weight	Approx. 0.25 kg ¹⁾
Start up torque	≤ 0.8 Ncm (at 20 °C)
Operating torque	≤ 0.6 Ncm (at 20 °C)
Permissible movement static	± 0.3 mm (radial) ± 0.5 mm (axial)
Permissible movement dynamic	± 0.05 mm (radial) ± 0.1 mm (axial)
Max. angular acceleration	≤ 500,000 rad/s ²
Operating speed	6,000 min ⁻¹ ²⁾
Moment of inertia of the rotor	56 gcm ²
Bearing lifetime	3.6 x 10 ⁹ revolutions ³⁾

¹⁾ Relates to encoders with male connector.

²⁾ Allow for self-heating of approx. 3.0 K per 1,000 rpm regarding the permissible operating temperature.

³⁾ On maximum operating speed and temperature.

Ambient data

EMC	According to EN 61000-6-2, EN 61000-6-3 and IEC 61326-3-1
Enclosure rating	IP65 (according to IEC 60529) ¹⁾
Permissible relative humidity	90 %, Condensation not permitted

¹⁾ With male connector and mating connector fitted minimum IP65.

²⁾ At operating temperature measuring point.

³⁾ Checked during operation using vector length monitoring.

⁴⁾ Checked to operation with vector length monitoring. Including mating connector.

Operating temperature range	-30 °C ... +95 °C ²⁾
Storage temperature range	-30 °C ... +90 °C, without package
Resistance to shocks	100 g, 6 ms (according to EN 60068-2-27) ³⁾
Frequency range of resistance to vibrations	30 g, 10 Hz ... 1,000 Hz (EN 60068-2-6) ⁴⁾

¹⁾ With male connector and mating connector fitted minimum IP65.

²⁾ At operating temperature measuring point.

³⁾ Checked during operation using vector length monitoring.

⁴⁾ Checked to operation with vector length monitoring. Including mating connector.

Classifications

ECl@ss 5.0	27272501
ECl@ss 5.1.4	27272501
ECl@ss 6.0	27272590
ECl@ss 6.2	27272590
ECl@ss 7.0	27272590
ECl@ss 8.0	27272590
ECl@ss 8.1	27272590
ECl@ss 9.0	27272590
ECl@ss 10.0	27272501
ECl@ss 11.0	27272501
ETIM 5.0	EC001486
ETIM 6.0	EC001486
ETIM 7.0	EC001486
UNSPSC 16.0901	41112113

Dimensional drawing (Dimensions in mm (inch))

Through hollow shaft, radial male connector M12 and M23

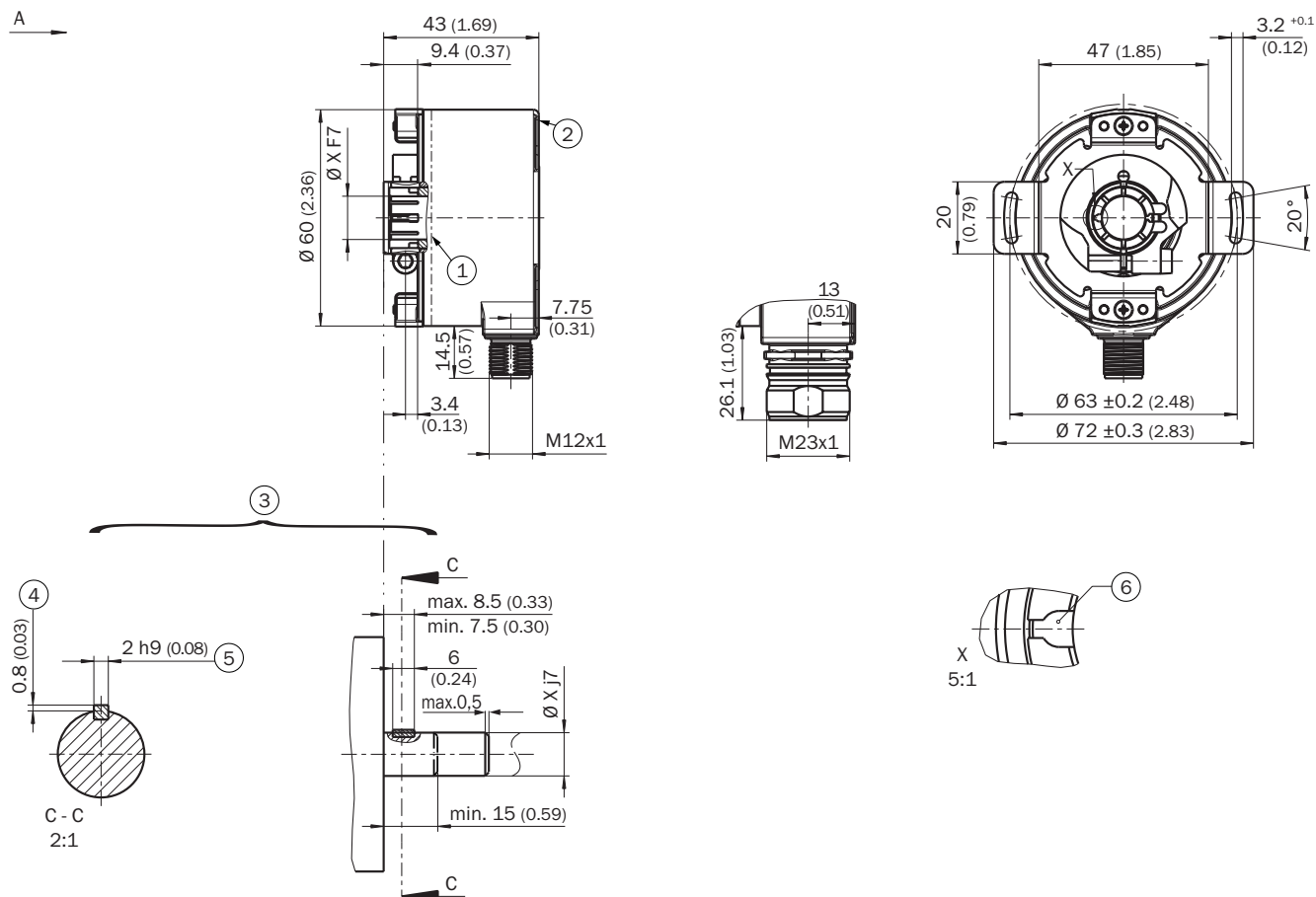

General tolerances according to DIN ISO 2768-mk

- ① Operating temperature measuring point (freely selectable, around the housing surface area in each case, approx. 3 mm away from flange)
- ② Measuring point vibration (respectively at the housing face. approx. 3 mm away from the cover edge)
- ③ Attachment specifications
- ④ Max. 0.4 at $\varnothing 5/8"$
- ⑤ Feather key DIN 6885-A 2x2x6
- ⑥ Feather key groove

Shaft diameter XF7	Shaft diameter xj7
6 mm	Provided by customer
8 mm	
3/8"	
10 mm	
12 mm	
1/2"	
14 mm	
15 mm	
5/8"	

PIN assignment

View of the M12 male connector plug-in face

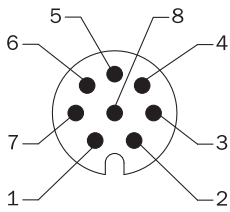

Connection type	+ U _S	Zulässige Leitungslänge bei maximaler Ausgangsfrequenz in Abhängigkeit der Versorgungsspannung ¹⁾
Male connector	4,5 V ... 5,0 V	50 m
	5,0 V ... 7,0 V	100 m
	7,0 V ... 30 V	150 m
Cable	4,5 V ... 5,0 V	50 m - (4 x Leitungslänge Encoder)
	5,0 V ... 7,0 V	100 m - (4 x Leitungslänge Encoder)
	7,0 V ... 30 V	150 m - (4 x Leitungslänge Encoder)

¹⁾ Datenleitung 4 x 2 x 0,25 mm² + 2 x 0,5 mm² + 1 x 0,14 mm² mit Abschirmung (für US, GND 2 x 0,5 mm²), Art.Nr. 6027530

Diagrams

Signal SIN/COS after differential generation

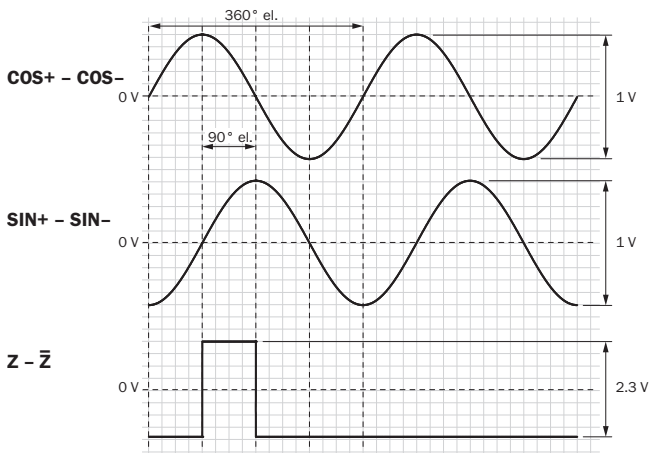

For clockwise shaft rotation, looking in direction "A" (see dimensional drawing)

Signal SIN/COS before differential generation

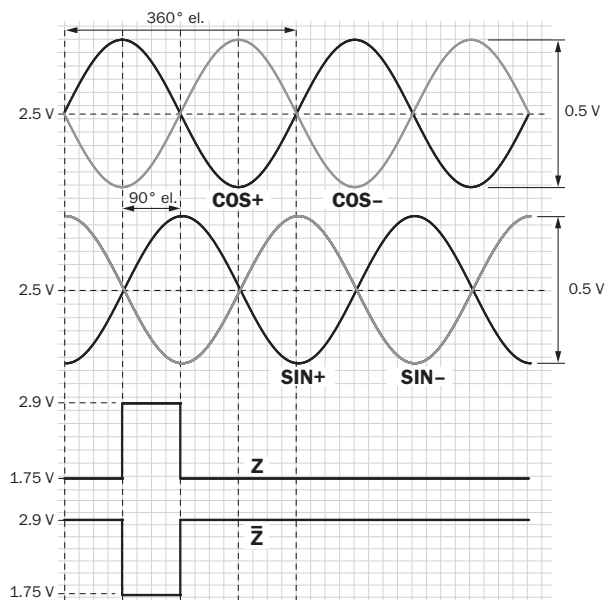



For clockwise shaft rotation, looking in direction “A” (see dimensional drawing)

Recommended accessories

Other models and accessories → www.sick.com/DFS60S_Pro

	Brief description	Type	Part no.
Plug connectors and cables			
	Head A: cable Head B: Flying leads Cable: SSI, Incremental, HIPERFACE®, PUR, halogen-free, shielded	LTG-2308-MWENC	6027529
	Head A: cable Head B: Flying leads Cable: SSI, Incremental, PUR, shielded	LTG-2411-MW	6027530
	Head A: cable Head B: Flying leads Cable: SSI, Incremental, PUR, halogen-free, shielded	LTG-2512-MW	6027531
	Head A: cable Head B: Flying leads Cable: SSI, TTL, HTL, Incremental, PUR, halogen-free, shielded	LTG-2612-MW	6028516
	Head A: female connector, M12, 8-pin, straight Head B: Flying leads Cable: Incremental, SSI, PUR, halogen-free, shielded, 2 m	DOL-1208-G02MAC1	6032866
	Head A: female connector, M12, 8-pin, straight Head B: Flying leads Cable: Incremental, SSI, PUR, halogen-free, shielded, 5 m	DOL-1208-G05MAC1	6032867
	Head A: female connector, M12, 8-pin, straight Head B: Flying leads Cable: Incremental, SSI, PUR, halogen-free, shielded, 10 m	DOL-1208-G10MAC1	6032868
	Head A: female connector, M12, 8-pin, straight Head B: Flying leads Cable: Incremental, SSI, PUR, halogen-free, shielded, 20 m	DOL-1208-G20MAC1	6032869

	Brief description	Type	Part no.
	Head A: female connector, M12, 8-pin, straight, A-coded Head B: male connector, M12, 8-pin, straight, A-coded Cable: PUR, halogen-free, shielded, 2 m Drag chain use	YF2AA8-020S01MKA18	2099207
	Head A: female connector, M12, 8-pin, straight, A-coded Head B: male connector, M12, 8-pin, straight, A-coded Cable: PUR, halogen-free, shielded, 5 m Drag chain use	YF2AA8-050S01MKA18	2099209
	Head A: female connector, M12, 8-pin, straight, A-coded Head B: male connector, M12, 8-pin, straight, A-coded Cable: PUR, halogen-free, shielded, 10 m Drag chain use	YF2AA8-100S01MKA18	2099210
	Head A: female connector, M12, 8-pin, straight, A-coded Head B: male connector, M12, 8-pin, straight, A-coded Cable: PUR, halogen-free, shielded, 20 m Drag chain use	YF2AA8-200S01MKA18	2099208
	Head A: female connector, M12, 8-pin, straight, A-coded Head B: - Cable: Incremental, SSI, shielded	DOS-1208-GA01	6045001
	Head A: male connector, M12, 8-pin, straight, A-coded Head B: - Cable: Incremental, shielded	STE-1208-GA01	6044892

SICK AT A GLANCE

SICK is one of the leading manufacturers of intelligent sensors and sensor solutions for industrial applications. A unique range of products and services creates the perfect basis for controlling processes securely and efficiently, protecting individuals from accidents and preventing damage to the environment.

We have extensive experience in a wide range of industries and understand their processes and requirements. With intelligent sensors, we can deliver exactly what our customers need. In application centers in Europe, Asia and North America, system solutions are tested and optimized in accordance with customer specifications. All this makes us a reliable supplier and development partner.

Comprehensive services complete our offering: SICK LifeTime Services provide support throughout the machine life cycle and ensure safety and productivity.

For us, that is “Sensor Intelligence.”

WORLDWIDE PRESENCE:

Contacts and other locations –www.sick.com